

CREATING POWER SOLUTIONS.

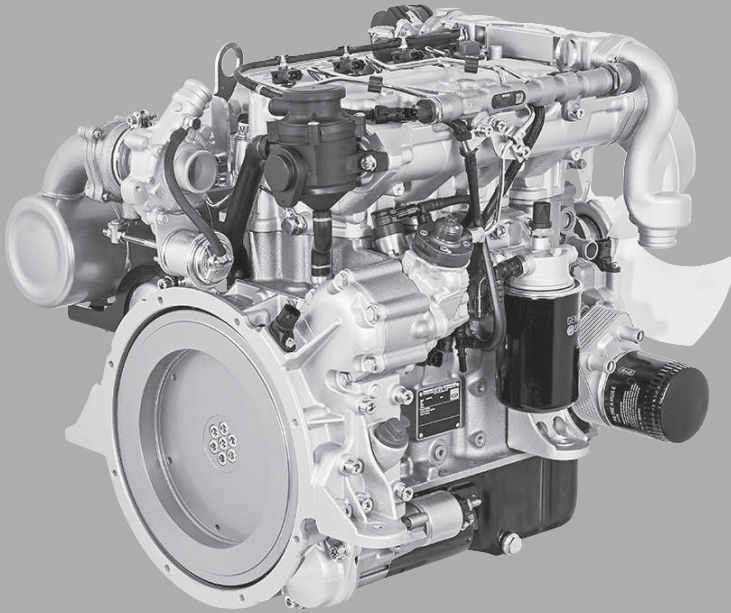

INCLUDES SUPPLEMENTAL INFORMATION TO
THE OWNER'S MANUAL FOR MODEL YEAR 2018
FOR EPA AND CALIFORNIA CERTIFIED NON-
ROAD COMPRESSION IGNITION ENGINES.

4H50TIC

OPERATOR'S MANUAL Diesel engine

Hatz Diesel

www.HATZ-DIESEL.com

1	Notices	5
2	General information	6
3	Safety	7
3.1	General information	7
3.1.1	Intended use and foreseeable misuse	7
3.1.2	Machine user or machine manufacturer obligations	8
3.1.3	Representation of safety notes	9
3.1.4	Meaning of safety symbols	10
3.2	Safety notes	12
3.2.1	Operational safety	12
3.2.2	Machine-specific safety instructions for operation	15
3.2.3	Machine-specific safety instructions for maintenance work	16
3.2.4	Electrical equipment	18
3.3	Labels	19
4	Technical data	21
4.1	Engine information and filling quantities	21
4.2	Engine type plate	22
4.3	Engine oil	23
4.4	Coolant	24
4.5	Fuel	29
5	Engine overview	30
5.1	Designation of components	30
5.2	HATZ instrument box	40
6	Transport, assembly and commissioning	44
6.1	Transport	44
6.2	Installation notes	47
6.3	Preparations for commissioning	48
6.4	Filling engine oil (first filling)	49
6.5	Filling the cooling system	50
6.6	Starting the engine for the first time or after a fuel filter replacement	52
7	Operation and use	56
7.1	Safety notes	56
7.2	Performing tests	57
7.3	Starting the engine	58
7.4	Switching off the engine	60
7.5	Check the oil level	62
7.6	Refueling	64
8	Maintenance	65
8.1	General maintenance instructions	65

8.2	Maintenance work.....	66
8.2.1	Maintenance plan	66
8.2.2	Additional work on the Silent Pack	68
8.2.3	Checking the intake area of the combustion air.....	72
8.2.4	Checking the radiator fins for dirt accumulation.....	74
8.2.5	Checking the cooling system	75
8.2.6	Changing the engine oil and oil filter.....	78
8.2.7	Engine cleaning	84
8.2.8	Checking the poly v belt.....	87
8.2.9	Checking and setting the belt tension.....	89
8.2.10	Replacing the poly v belts.....	92
8.2.11	Changing the oil separator of the crankcase ventilation	96
8.2.12	Checking the screw connections	97
8.2.13	Draining the water separator	98
8.2.14	Changing the fuel prefilter.....	99
8.2.15	Changing the main fuel filter	101
8.2.16	Servicing the air filter (optional)	104
8.2.17	Changing coolant.....	106
8.2.18	Resetting the maintenance interval indicator	109
9	Faults.....	110
9.1	Troubleshooting	110
9.2	Flash code table for engine faults	113
9.3	Start support	116
10	Storage and disposal.....	121
10.1	Storing the machine.....	121
10.2	Disposing of the machine	123
11	Installation declaration	124
12	EPA AND CARB CERTIFIED ENGINES	125

1 Notices

Contact data

© 2018
Motorenfabrik HATZ
Ernst-Hatz-Straße 16
94099 Ruhstorf
Germany
Tel. +49 (0)8531 319-0
Fax +49 (0)8531 319-418
marketing@hatz-diesel.de
www.hatz-diesel.com
All rights reserved!

Copyright

The copyright for this manual rests entirely with Motorenfabrik HATZ, Ruhstorf.

This manual may only be copied or distributed if written approval has been received. This also applies to the copying or distribution of excerpts of this manual. The same conditions apply to distribution of this manual to third parties in digital form.

Original manual

This manual has been translated into multiple languages.

The German version is the **original manual**. All other language versions are **translations** of the **original manual**.

2 General information

Information on the document

This manual was created with due care. It is exclusively intended to offer a technical description of the machine and to provide instructions on commissioning, operating and maintaining the machine. When operating the machine, the applicable standards and legal regulations as well as any in-house regulations apply.

Before commissioning, during operation and before maintenance work is begun on the machine, read this manual carefully and keep it close by for ready access.

Machine

This manual describes the following machine.

Machine name	HATZ diesel engine
Type number	4H50TIC

Customer service

Have service work performed by qualified technicians only. We recommend that you work with one of the over 500 **HATZ service stations**. Trained specialists there will repair your machine with **Hatz original spare parts** and with **HATZ tools**. The global HATZ service network is at your disposal to advise you and supply you with spare parts. For the address of the **Hatz service station** nearest you, please see the enclosed spare parts list or visit us in the Internet at: **www.hatz-diesel.com**

Installation of unsuitable spare parts can lead to problems. We cannot accept responsibility for direct damage or secondary damage that results from this.

We therefore recommend the use of **Hatz original spare parts**. These parts are manufactured according to strict Hatz specifications and achieve maximum operational reliability through their perfect fit and functionality. The order number can be found in the enclosed spare parts list or on the Internet at: **www.hatz-diesel.com**

Exclusion of liability

The manufacturer cannot be held responsible for personal injury, damage to property or damage to the machine itself caused by improper use, foreseeable misuse, or failure to follow or adequately follow the safety measures and procedures described in this manual. This also applies to changes made to the machine and the use of unsuitable spare parts.

Modifications, which serve the technical improvements, are reserved

3 Safety

3.1 General information

Introduction

This chapter contains the information you need to work safely with this machine.

To prevent accidents and damage to the machine, it is imperative that these safety instructions be followed.

Read this chapter carefully before beginning work.

3.1.1 Intended use and foreseeable misuse

Intended use

The machine described in this manual fulfills the following functions:

- Diesel engine intended for installation in a machine or for assembly with other machines to form a machine. See chapter *11 Installation declaration*, page 124.

This engine is intended exclusively for the purpose specified and tested by the manufacturer of the machine in which the engine is installed.

Any other use is not intended and therefore not permitted. Violations compromise the safety of the personnel working with the machine. Motorenfabrik HATZ does not accept any liability for damage resulting from this.

The operational safety of the machine is only guaranteed if it is used as intended.

The intended use also includes observance of the instructions in this Operator's Manual to preserve the environment, including the appendix for EPA and CARB certified engines.

Foreseeable misuse

The following is considered to be foreseeable misuse:

- Any use that varies from or extends beyond the uses specified above.
- Failure to comply with the instructions given in this manual.
- Failure to comply with the safety instructions.
- Failure to immediately eliminate malfunctions that impact safety before continuing work with the machine (working with the machine when it is not in perfect condition, either functionally or in terms of safety).
- Failure to perform the necessary inspection and maintenance work.
- Any unauthorized modification of or removal of safety equipment.
- Use of spare parts and accessories that are unsuitable or have not been approved by HATZ.
- Operation in flammable or hazardous environments.
- Operation in closed-off or poorly ventilated rooms.

- Installation of the machine in mobile equipment (e.g. vehicles, trailers) or in closed rooms without additional measures to handle supply air, extract air, and exhaust gas.
- Improper operation at variance with DIN 6271 and DIN ISO 8528 (climate, load, safety).

Residual risks

Residual risks result during daily use and in association with maintenance work.

These residual risks will be pointed out in chapter 3.2.2 *Machine-specific safety instructions for operation, page 15* and in chapter 3.2.3 *Machine-specific safety instructions for maintenance work, page 16* as well as in the further contents of the manual, directly in front of the descriptions or operating instructions concerned.

3.1.2 Machine user or machine manufacturer obligations

Machine manufacturer obligations

If you have an engine that is not yet installed in a machine, it is imperative that you follow the **Assembly Instructions for HATZ Diesel Engines** before installing the engine. These assembly instructions contain important information on how to safely install the engine and are available at your nearest **HATZ service station**.

It is prohibited to start the engine before it is fully installed.

In addition, please note that it is prohibited to start up the machine before it has been determined that the machine into which this engine is installed fulfills all safety-related requirements and legal regulations.

User obligations

The operator is obliged to only operate the machine when it is in perfect condition. The operator must check the condition of the machine before use and ensure that any defects are eliminated before it is taken into service. Running the machine while identified defects exist is not permitted. The user must also ensure that all persons who work on the machine are familiar with the contents of this manual.

Obligations of the operating and maintenance personnel

Personnel assigned with operating and maintaining the machine must have read and understood this manual or must possess the qualifications necessary for working with this equipment, acquired in training/instructional courses. No one may work with the machine without the necessary qualifications, even if for just a brief period.

The operating personnel must not be under the influence of drugs, medication or alcohol.

All work performed on the machine must be in compliance with the information provided in this manual.

Storing this manual

This manual is an integral component of the machine (also when being sold). It must be stored in the direct vicinity of the machine and be accessible to personnel at all times.

3.1.3 Representation of safety notes

Overview

This machine has been designed and built according to state-of-the-art technology and the recognized safety standards. Despite these precautions, risks exist when operating the machine and during maintenance work.

These risks are identified in this manual by means of safety notes.

The safety notes precede the related description or operating step.

Structure of the safety notes

The safety notes consist of:

- Danger symbol
- signal word
- Description of danger
- Possible consequences
- Preventative measures



General danger symbol



The general danger symbol is used to identify the danger of personal injury.

Signal words





Signal words identify the magnitude of the risk and the seriousness of the possible injuries:







Danger symbol/ signal word	Meaning
 DANGER	This signal word is used to indicate imminently dangerous situations which, if not avoided, will lead to serious injury or death.
 WARNING	This signal word is used to indicate potentially dangerous situations which, if not avoided, may lead to serious injury or death.
 CAUTION	This signal word is used to indicate potentially dangerous situations which, if not avoided, may lead to minor or moderate injury.
CAUTION	This signal word, without a danger symbol, is used to indicate the risk of property damage.
NOTICE	This signal word indicates additional useful information, such as operating tips and cross references.

3.1.4 Meaning of safety symbols

Explanation of symbols

The following table describes the meanings of the safety symbols used in this manual.

Symbol	Meaning
	Smoking, fire, and open flames are prohibited!
	Warning of personal injury!
	Warning of hot surfaces!
	Warning of flammable substances!



Symbol	Meaning
	Warning of explosive substances!
	Warning of toxic engine exhaust!
	Warning of corrosive substances!
	Warning of heavy loads!
	Warning of environmental damage!
	Comply with this manual or additional documentation from other manufacturers or the carrier.
	Additional information that is useful to the reader.

3.2 Safety notes

3.2.1 Operational safety

Introduction

This chapter contains all of the important safety instructions for personal protection and for safe and reliable operation. Additional, task-related safety instructions can be found at the beginning of each chapter.

 DANGER	
	<p>Danger to life, danger of injury or danger of property damage due to failure to comply with this manual and the safety instructions contained therein.</p> <ul style="list-style-type: none">▪ As the operator of the machine, you must ensure that all people working on the machine are familiar with the content of this manual.▪ Before working on the machine, read this manual carefully, paying special attention to the safety notes.▪ Fulfill all required safety conditions before working on the machine.▪ Follow all general safety instructions as well as the specific task-related safety instructions contained in the individual chapters.

Using the machine

- Only operate the machine for the purposes described in chapter 3.1.1 *Intended use and foreseeable misuse*, page 7.

Compliance with other regulations

- Adhere to the applicable accident prevention regulations of the trade associations.
- Comply with the regulations concerning the minimum safety and health requirements for the use of work equipment by workers at work.
- In addition, local safety, accident prevention and environmental regulations also apply when operating the machine.

Personal protective equipment

During operation and maintenance of the machine, personal protective equipment must be available and must be used if necessary. The required personal protective equipment is specified in the descriptions of the operating steps.

Personal protective equipment	Pictogram	Function
Safety shoes		Safety shoes offer protection against: <ul style="list-style-type: none"> ▪ Slipping ▪ Falling objects
Hearing protection		Hearing protection offers protection against ear injuries due to excessive and constant noise.
Safety gloves		Safety gloves protect the hands against injury, e.g. from battery acid.
Safety goggles (with side protection)		Safety goggles protect the eyes from flying objects (e.g. dust particles, spraying liquids, spraying acid).
Working clothes		Wear close-fitting clothing. However, it must not restrict the wearer's freedom of movement.

Warning labels and information signs on the machine

The warning labels and information signs on the machine must be followed (see chapter "Labels" 3.3 *Labels*, page 19).

The warning labels and information signs must be kept legible and must be replaced if necessary. For this purpose, contact your nearest **HATZ service station**.

Maintenance work









Maintenance work that goes beyond the scope described in this manual must only be performed by qualified technicians (see chapter 2 *General information*, page 6).

Independent maintenance work and constructional changes to the machine, especially to the safety equipment, are not permitted.

Safety equipment

Safety equipment must not be modified and must not be rendered ineffective during normal operation.

General safety instructions

 DANGER	
	<p>Danger to life and danger of injury due to failure to follow the warnings on the machine and in this manual.</p> <ul style="list-style-type: none"> ▪ Heed the warnings on the machine and in this manual.
 WARNING	
	<p>Danger of injury and danger of incorrect operation due to inadequate personnel qualifications.</p> <ul style="list-style-type: none"> ▪ The personnel must have read and understood this manual or must possess the qualifications necessary for working with this equipment, acquired in training/instructional courses. ▪ Only qualified personnel is permitted to operate and maintain this machine. ▪ Failure to comply will cause the warranty to become void.
 WARNING	
	<p>Danger of injury from failure to follow the operating instructions and from performing unauthorized tasks on the machine.</p> <ul style="list-style-type: none"> ▪ Follow all instructions. ▪ Do not perform activities for which no qualification is available. Contact properly trained personnel if necessary.
 CAUTION	
	<p>Danger of injury from overloading the body.</p> <p>Lifting the machine to transport it or to move it to another location can lead to injuries (of the back, for example).</p> <ul style="list-style-type: none"> ▪ Only lift the machine with a hoist (see chapter 6.1 <i>Transport</i>, page 44).

3.2.2 Machine-specific safety instructions for operation

Introduction

The machine can pose residual risks during operation. To eliminate these risks, all persons working on the machine must follow the general and machine-specific safety instructions.

If you have an engine that is not yet installed in a machine, it is imperative that you follow the **Assembly Instructions for HATZ Diesel Engines** before installing the engine.

These assembly instructions contain important information on safe installation.

If the engine is installed in a machine or assembled with other machines to form a machine, it is prohibited to start the engine before it has been determined that the newly created machine fulfills all safety-related requirements and applicable legal regulations.



Safe operation



- Before switching on the machine, ensure that no one can be injured when the machine is started up.
- During machine operation, ensure that unauthorized persons do not have access to the area in which the machine has an impact.
- Parts of the exhaust gas system and the surface of the engine become hot during operation. Risk of injury from touching hot parts! Let the engine cool before maintenance.
- Do not refuel during operation.

Faults

- Immediately eliminate faults that compromise safety.
- Switch off the machine and do not take into service again until all faults have been eliminated.

Safety instructions for operation

 DANGER	
	<p>Danger to life from inhaling exhaust gases.</p> <p>Toxic engine exhaust gases can lead to loss of consciousness and even death in closed-off and poorly ventilated rooms.</p> <ul style="list-style-type: none"> ▪ Never operate the machine in closed-off or poorly ventilated rooms. ▪ Do not breathe in the exhaust gases.

 DANGER	
 	<p>Fire hazard from fuel.</p> <p>Leaked or spilled fuel can ignite on hot engine parts and cause serious burn injuries.</p> <ul style="list-style-type: none"> ▪ Only refuel when the engine is switched off. ▪ Never refuel in the vicinity of open flames or sparks that can cause ignition. ▪ Do not smoke. ▪ Do not spill fuel.

3.2.3 Machine-specific safety instructions for maintenance work

Introduction

The machine can pose residual risks during maintenance. To eliminate these risks, all persons working on the machine must follow the general and machine-specific safety instructions.

Maintenance intervals

- Strictly adhere to the maintenance intervals.
Regular maintenance according to the instructions in this manual is essential for ensuring reliable operation and the correct engine exhaust quality.
- Check the safety equipment regularly to ensure it is in good condition and functioning properly.
- Check connections, cables and fasteners regularly to ensure they are in good condition.

Maintenance work

Maintenance work that goes beyond the scope described in this manual must only be performed by qualified technicians. We recommend that you work with one of the over 500 **HATZ service stations**.









Replacing parts

- When replacing defective components, we recommend that you use **genuine HATZ original spare parts** (see chapter 2 *General information*, page 6).
- When disposing of parts that can no longer be used, do so in accordance with local environmental regulations or send them to a recycling center.

Measures following maintenance and troubleshooting







- Securely reconnect loose electrical connections; check that the electrical components and equipment are functioning properly.
- Check the entire machine for foreign bodies; remove any foreign bodies.

Safety instructions for maintenance work

 DANGER	
	<p>Danger of explosion from flammable cleaning agents.</p> <p>Cleaning with benzene is an explosion hazard. It is highly flammable, can become electrostatically charged, and can generate an explosive gas/air mixture.</p> <ul style="list-style-type: none"> ▪ Use halogen-free, cold cleaners with a high flashpoint for cleaning. ▪ Comply with manufacturer's instructions.
 WARNING	
 	<p>Danger of injury from compressed air and dust particles.</p> <p>Eye injuries may occur when cleaning with compressed air.</p> <ul style="list-style-type: none"> ▪ Wear safety goggles.
 CAUTION	
	<p>Danger of injury if maintenance instructions are not followed.</p> <ul style="list-style-type: none"> ▪ Only perform maintenance when the engine is switched off. ▪ For engines with an electric starter: Disconnect the negative battery terminal. Protect the starting key against unauthorized access.
 CAUTION	
	<p>Danger of burns.</p> <p>There is a danger of burns when working on a hot engine.</p> <ul style="list-style-type: none"> ▪ Let the engine cool before maintenance.

3.2.4 Electrical equipment

Safety notes

 DANGER	
	<p>Danger to life, danger of injury or danger of property damage due to incorrect use of batteries.</p> <ul style="list-style-type: none"> ▪ Do not place tools or other metal objects on the battery. ▪ Before performing work on the electrical equipment, always disconnect the negative battery terminal. ▪ Never swap the positive (+) and negative (–) battery terminals. ▪ When installing the battery, first connect the positive cable and then the negative cable. ▪ When removing the battery, first disconnect the negative cable and then the positive cable. ▪ It is imperative to prevent short circuits and mass contact of current carrying cables. ▪ If faults occur, check the cable connections for good contact.
 DANGER	
	<p>Danger of explosion from flammable substances.</p> <p>There is a danger of explosion from flammable gases.</p> <ul style="list-style-type: none"> ▪ Keep batteries away from open flames and incendiary sparks. ▪ Do not smoke when working with batteries.
 CAUTION	
	<p>Danger of chemical burns</p> <p>Chemical burns can occur when using batteries for the electrical operation.</p> <ul style="list-style-type: none"> ▪ Protect your eyes, skin, and clothing from corrosive battery acid. ▪ Immediately rinse areas affected by splashed acid with clear water and consult a physician if necessary.

NOTICE

- The necessary wiring diagrams are included with the machine if it is equipped with electrical equipment. Additional wiring diagrams can be requested when needed.
- We cannot be held liable for electrical equipment that is not designed according to HATZ wiring diagrams.

- Promptly replace faulty indicator lamps.
- Do not pull out the starting key during operation.
- Do not disconnect the battery while the machine is running. Resulting voltage peaks could destroy the electronic components.
- When performing welding work on the machine, disconnect the battery and place the ground clamp of the welding equipment as close as possible to the welding area. Disconnect the plug connectors to the engine control unit and to the voltage regulator of the three phase alternator.

3.3 Labels**Warning labels and information signs on the engine**

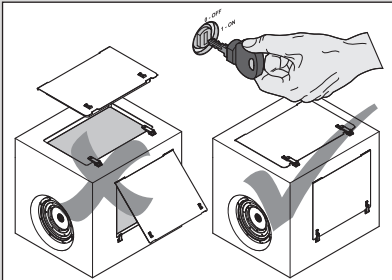
Label	Meaning
Engine specification TIC	
	<p>The engine may only be operated with fuel that is "EXTREMELY LOW IN SULFUR OR SULFUR-FREE". The fuel label is located close to the fuel cap. If there is no fuel tank installed on the engine, the label must be applied permanently close to the fuel filler opening.</p>
Engine specification Silent Pack	
 <p style="text-align: right;">0000 036 144 03</p>	<p>CAUTION! Danger of injury from rotating parts.</p> <ul style="list-style-type: none"> ▪ Only operate the engine when all covers are installed.

Warning labels and information signs on the battery (option)

Label	Meaning
	<ol style="list-style-type: none"> 1. Fire, sparks, open flames and smoking are prohibited: avoid causing sparks when working with cables and electrical machines. Avoid short-circuits. 2. Follow the instructions on the battery and in the battery user manual. 3. Keep children away from acid and batteries. 4. Danger of explosion: A highly explosive electrolytic gas is created when batteries are charged. 5. Wear safety goggles when filling. 6. Danger of chemical burns: Battery acid is highly corrosive. Therefore, wear safety gloves and eye protection. Do not tilt the battery; acid may spill out of the vent openings. 7. Do not dispose of the battery with the household trash. 8. Take the used battery to a collection center.

4 Technical data

4.1 Engine information and filling quantities

Type		4H50
Type		Liquid-cooled four stroke diesel engine
Combustion system		Direct injection
Number of cylinders		4
Bore/stroke	mm	84 / 88
Displacement	Liter	1,952
Engine oil capacity	Approx. L.	7.0 ¹⁾
Difference between the "max." and "min." marks	Approx. L.	1.0 ¹⁾
Engine oil consumption (after running-in period)	Max.	0.5 % of fuel consumption, pertaining to full load
Engine oil pressure		2.5 bar to 4.5 bar
Coolant quantity	Approx. L.	13.2 ²⁾ / 12.5 ³⁾
Sense of rotation		Left (view toward flywheel)
Tappet clearance		Automatic hydraulic valve adjustment (maintenance-free)
Max. perm. continuous sloping position ⁴⁾		HATZ radiator with integrated expansion tank exhaust low: 20°, radiator low: 20°, other parts: 30°
		HATZ radiator with external expansion tank exhaust low: 20°, other parts: 30°
Battery capacity	Max.	12 V – 110 Ah / 450 A as per DIN
		24 V – 66 Ah / 300 A as per DIN

¹⁾ These values are approximations only. The max. mark on the dipstick is decisive in any case (see section 7.5 *Check the oil level*, page 62).

²⁾ HATZ radiator with integrated expansion tank.

³⁾ HATZ radiator with external expansion tank.

⁴⁾ Exceeding these limit values can cause engine damage.

Engine specifications

Model	Description
TIC	with turbocharger, charge air cooling, cooled exhaust gas recirculation (EGR) and diesel oxidation catalyst (DOC)
OPU	Open Power Unit. Complete system with all components required for engine cooling.
Silent Pack	Open Power Unit with noise and weather protection capsule.

Weights (without operating fluids)

	Model		
	Standard	OPU	Silent Pack
Type	Weight in kg		
4H50 TIC	226 *	255	360

* with HATZ radiator.

Screw tightening torque

Designation	Nm
Oil drain screw	50
Drain plug on the radiator	50
Screws for the breather cap of the crankcase ventilation	4

4.2 Engine type plate

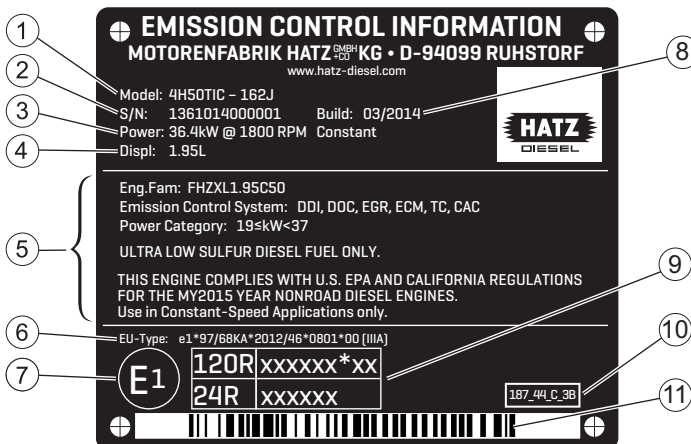

The engine type plate is located on the crankcase and contains the following engine information:

1	Model designation of the engine
2	Engine serial number
3	Serial rating (kW) at nominal speed (rpm)
4	Displacement (liters)
5	Information for US emission certification (EPA/CARB)
6	EU type approval
7	EU country of origin (Germany)
8	Model year (month/year)
9	ECE type approval numbers
10	Code for type plate variant
11	Barcode (engine serial number)

The following data must always be specified in case of queries and for spare parts orders:

1	Model designation
2	Engine serial number

4.3 Engine oil

Oil quality

All oil brands that meet at least one of the following specifications are suitable:

- **ACEA E6** (recommended)
- **ACEA E9**
- **ACEA C3 / C4** (HTHS \geq 3.5 mPas)
- **API CJ-4**

CAUTION

Damage to the diesel oxidation catalyst (DOC) from using unsuitable engine oil.

Unsuitable engine oil diminishes the functionality and service life of the catalytic converter.

Only use engine oils with very low quantities of sulfate ash, phosphor and sulfur – so-called "low SAPS" oils which fulfill at least one of the specifications mentioned above.

Oil viscosity

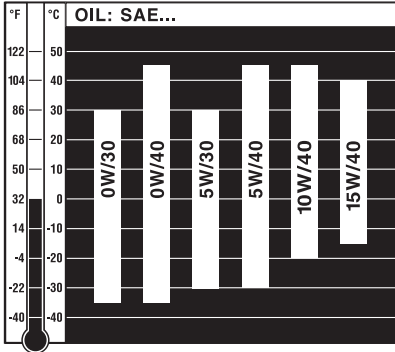

Select the recommended viscosity depending on the ambient temperature in which the engine will be operated.

CAUTION	
	<p>Engine damage from unsuitable engine oil.</p> <p>Unsuitable engine oil considerably reduces engine service life. Only use engine oil that fulfills the specifications stipulated above.</p>

4.4 Coolant

Introduction

Liquid-cooled engines require a coolant specified by HATZ for engine cooling.

Coolant is prepared in accordance with manufacturer's instructions, please comply with the information on the packaging label.

Radiator protection fluids give effective protection against corrosion and freezing. In addition, the coolant boiling point is significantly raised and deposits of lime in the cooling system are reduced.

Safety notes

CAUTION	
	<p>Danger of damage to health</p> <p>Radiator protection fluids are harmful to health.</p> <ul style="list-style-type: none"> ▪ Avoid contact to eyes and skin. ▪ Store only in the sealed original container and in a place inaccessible for unauthorized persons. ▪ Comply with manufacturer's instructions.

**CAUTION****Danger of environmental damage from spilled coolant.**

Coolant is water-polluting.

- Do not allow it to enter the ground water, water bodies, or sewage system.
- Collect the coolant and dispose of it according to local environmental regulations.

CAUTION**Danger of engine damage from radiator protection fluid.**

Use of a radiator protection fluid not approved by HATZ can cause engine damage.

- If you have any questions, please contact your nearest **HATZ Service** before commissioning the engine.

Recommended radiator coolant

Product name	Container	HATZ order no.
H50-Coolant	5 liters	0000 055 413 00

The **H50-Coolant** coolant concentrate is exactly matched to the requirements of your HATZ diesel engine.

Alternative radiator protection fluids

If H50-Coolant is not available, other radiator protection fluids are approved by HATZ:

Manufacturer	Product name
ARAL	Aral Antifreeze Silikatfrei (silicate-free)
Artego	Havoline XLC (OF02), Havoline XLC+B
Auto-Teile-Ring	Cartechnic Antifreeze CT 12 plus
Avia	AVIA ANTIFREEZE NG
BASF	Glysantin® G30®, Glysantin® G40®
BayWa AG	TECTROL COOLPROTECT SI-OAT
Belgin Madeni Yaglar Tic	LUBEX ANTIFREEZE G-12 PLUS
BP	BP Procool
Bucher	MOTOREX COOLANT M3.0 Concentrate, MOTOREX COOLANT M4.0 Concentrate
Castrol	Radicool SF, Radicool Si OAT

Manufacturer	Product name
CCI	LLC C521, LLC L415
CEPSA	XTAR SUPER COOLANT Si-OAT
CHEMIA-BOMAR	Glidex Extra Premium
Chevron	Caltex Delo XLC Antifreeze/Coolant – Concentrate, Chevron Delo XLC Antifreeze/Coolant – Concentrate, Havoline XLC Concentrate, Ursa ELC NF Concentrate, Texaco Havoline Xtended Life Coolant – Conc, Caltex Extended Life Coolant
CLASSIC	CLASSIC KOLDA UE G30, CLASSIC KOLDA UE G40
ENI S.p.A.	Eni Antifreeze Spezial 12++
Eurolub	Radiator protection fluid D-30, PROCAR radiator protection fluid silicate-free, radiator protection fluid D-40 SUPER
Exxon	Mobil Delvac ELC Coolant, Mobil Antifreeze Ultra
Finke Mineralölwerke	AVIATICON Finkofreeze F40
FRIPOO Produkte AG	polyston® G40®
Fuchs	MAINTAIN FRICOFIN G 12 PLUS, MAINTAIN FRICOFIN LL, MAINTAIN FRICOFIN DP
Gazpromneft-Lubricants	G-ENERGY ANTIFREEZE SNF
Huiles Berliet S.A.	RTO Maxigel Plus
INA MAZIVA Ltd.	INA Antifriz BS Super
JMC	JMC Kühlerschutz JM12 Plus
Krafft	K-140 Energy - Plus
Kemetyl	CARIX COOLANT PREMIUM LONGLIFE, GLYCOCOOL LONGLIFE PREMIUM ANTIF.774 D-F
Kuttenkeuler	Kuttenkeuler Antifreeze K 12 Plus, Antifreeze ANF KK40
LUKOIL	LUKOIL COOLANT SF, LUKOIL COOLANT SOT
Mitan	Alpine C12, Alpine C12+, Alpine C30, Alpine C40
MOL-LUB	EVOX Premium Concentrate

Manufacturer	Product name
Müller Mineralöle	Startol Top G 12 Plus, EVO ST40
Neste Markkinointi	Neste Superjäähdytinneste XLC, Neste Coolant Longlife M
OJSC Technoform	Cool Stream Premium
Old World Industries	Final Charge Global Coolant
Orvema	Protex® B-40
Pakelo Motor Oil S.r.l.	Pakelo Coolant G30 Red Long Life, Pakelo Coolant G40® Hybrid
PANOLIN AG	PANOLIN ANTI-FROST MT-650
Petrol Ofisi Anonim Sirketi	PO EXTENDED LIFE coolant
PETRONAS LUBRICANTS	PETRONAS ANTIFREEZE HT
REPSOL LUBRICANTES	REPSOL ANTI.REF.ORGANICO MAXIMUM QUALITY, REPSOL ANTICONGELANTE REF. ORGANICO Si-OAT
SMB	POWER COOLING NG
Tedex	Tedex Antifreeze OT LL
Total	Total Glacelf Auto Supra, TOTAL GLACELF Si-OAT
Valvoline	Zerex G 30, Zerex G 40-91
YORK SAS	YORK 718, YORK 816

Preparation of the coolant

CAUTION	
	<p>Danger of engine damage from incorrect radiator protection fluid concentration.</p> <p>A too low radiator protection fluid concentration increases the risk of corrosion and also the risk of the cooling system freezing. A radiator protection fluid proportion of over 50 vol% degrades the cooling action and also the protection against frost is reduced. Therefore, serious engine damage may result from exceeding or dropping below the radiator protection fluid concentration.</p>

- The radiator protection fluid must be prepared according to manufacturer's instructions before pouring it into the cooling circuit. Comply with the information on the packaging label.
- If the radiator protection fluid has to be mixed with water, use only clean water that is not too hard. Drinking water with as low a content of salt, minerals and suspended matter as possible is ideal. Demineralized or distilled water is also ideal.

The following values must not be exceeded:

Water quality	Max.
Water hardness (°dGH)	20
Water hardness (mmol/l)	3.6
Chloride content (ppm)	100
Sulfate content (ppm)	100

The coolant mixture ratio must not be below or exceed the following concentration:

Radiator protection fluid	Water	Frost-resistant to approx.
min. 40 vol%	60 vol%	-27 °C
max. 50 vol%	50 vol%	-38 °C

NOTICE



As the corrosion and antifreeze concentration reduces with time, carry out an annual check with a commercially available antifreeze tester.

If the concentration is too low, either:

- drain part of the coolant and bring to the required frost safety level by adding radiator protective fluid, or
- replace the entire filling of coolant (see section 8.2.17 *Changing coolant, page 106*).

4.5 Fuel

Fuel type

All types of diesel fuel that meet the minimum requirements of the following specifications are suitable:

- **Europe: EN 590**
- **UK: BS 2869 A1 / A2**
- **USA: ASTM D 975-09a 1-D S15 or 2-D S15**
- **Japan: JIS K 2204** (with a maximum HFRR value of 520 µm)

CAUTION

Danger of engine damage from low quality fuel.

The use of fuel that does not meet the specifications can lead to engine damage.

- The use of fuel that does not meet specifications requires approval by Motorenfabrik HATZ (main plant).

CAUTION

Danger of malfunctions due to old fuel.

When diesel fuel is stored in a fuel tank or canister for lengthy periods, deposits may form on account of fuel aging. These deposits result in malfunctions due to clogged fuel filters and damage to the injection system.

- Perform the prescribed storage steps in machines that will be out of use for more than three months (see section *10.1 Storing the machine, page 121*).
- Only refuel with fresh diesel fuel such as can be obtained from filling stations.

5 Engine overview

5.1 Designation of components

Model – TIC
intake side

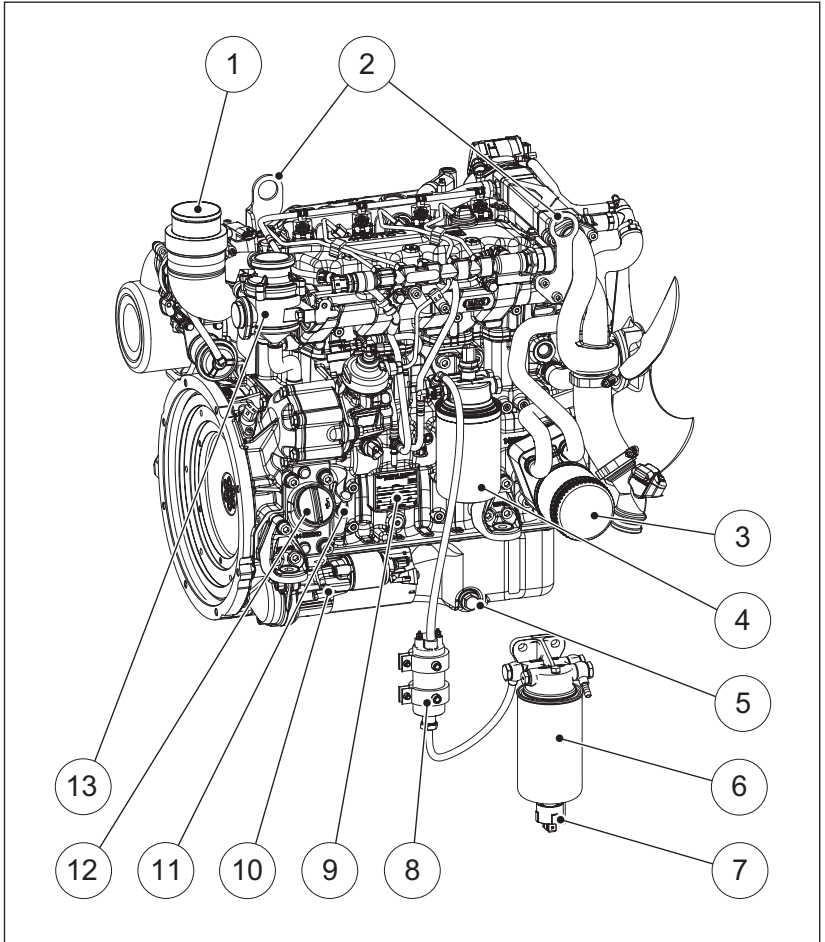

1	Intake opening for combustion air
2	Lifting eyes
3	Oil filter
4	Main fuel filter
5	Side oil drain screw

6	Fuel prefilter
7	Drain plug with integrated water level sensor
8	Electric fuel pump
9	Engine type plate
10	Starter (low mounting position)
11	Dipstick
12	Oil filler plug, bottom
13	Crankcase ventilation

Model – TIC
exhaust side

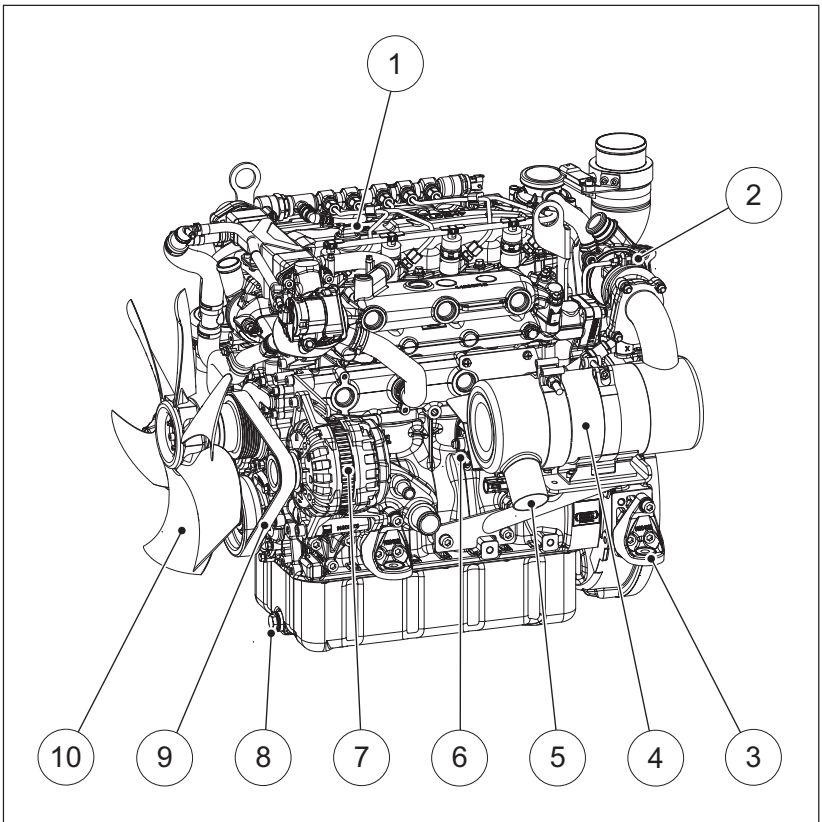

1	Oil filler plug, top
2	Turbocharger

3	Engine foot
4	Diesel oxidation catalyst (DOC)
5	Exhaust outlet
6	Starter (high mounting position)
7	Three phase alternator
8	Oil drain screw, front
9	Poly v belt
10	Fan

Model – OPU
intake side

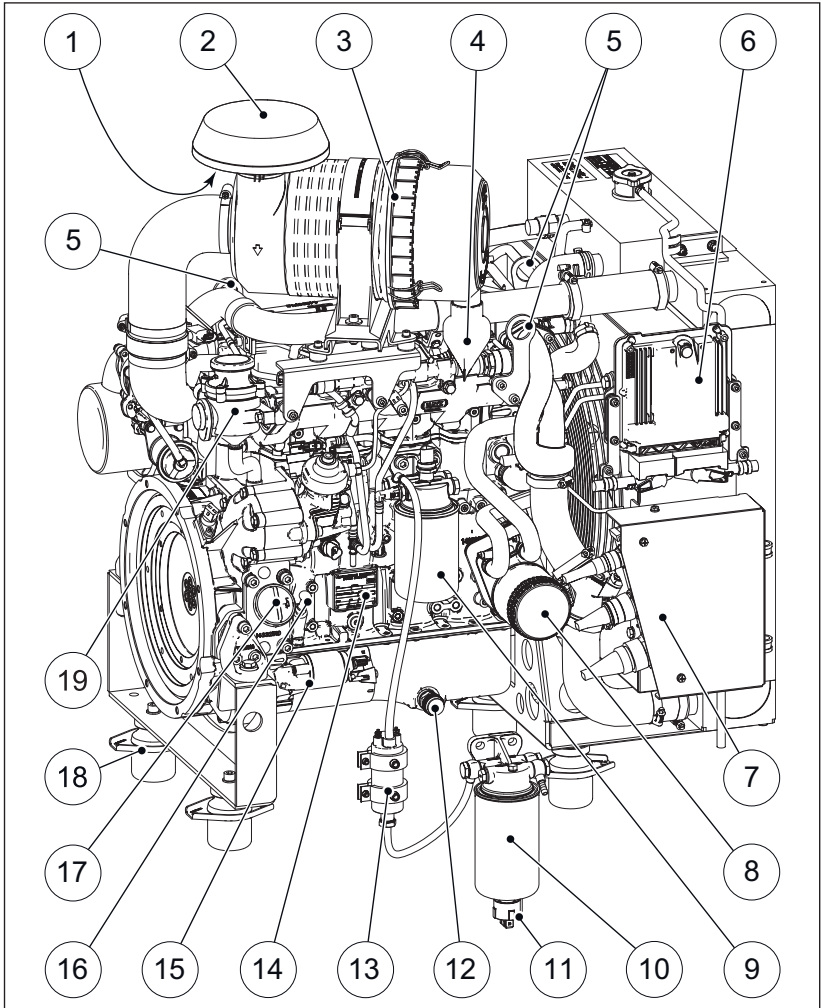

NOTICE



The Open Power Unit (OPU) is a complete system which, in addition to the engine, also includes all of the components required for cooling.

1	Intake opening for combustion air
2	Rain cap

3	Air filter (optional)
4	Dust discharge valve
5	Lifting eyes
6	Engine control unit
7	Plug holder with integrated relay, glow control unit and fuse holder
8	Oil filter
9	Main fuel filter
10	Fuel prefilter
11	Drain plug with integrated water level sensor
12	Side oil drain screw
13	Electric fuel pump
14	Engine type plate
15	Starter (low mounting position)
16	Dipstick
17	Oil filler plug, bottom
18	Vibration damper
19	Crankcase ventilation

Model – OPU
exhaust side

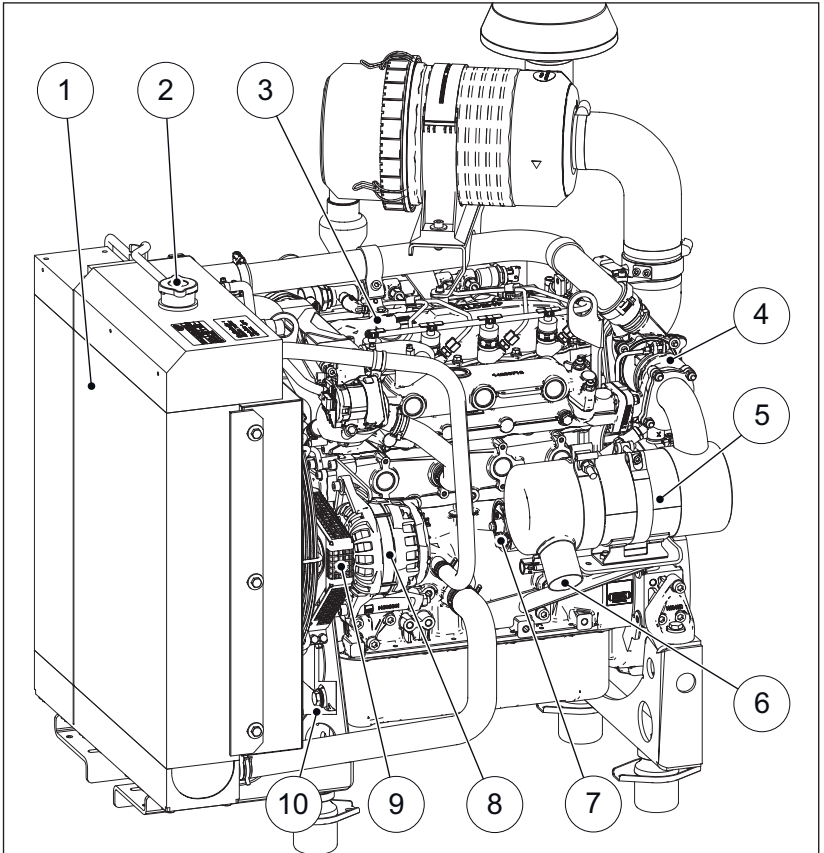

1	Radiator with integrated expansion tank
2	Sealing cap for coolant
3	Oil filler plug, top
4	Turbocharger
5	Diesel oxidation catalyst (DOC)
6	Exhaust outlet
7	Starter (high mounting position)
8	Three phase alternator
9	Belt guard (option)
10	Oil drain screw, front

Encapsulated model – Silent Pack

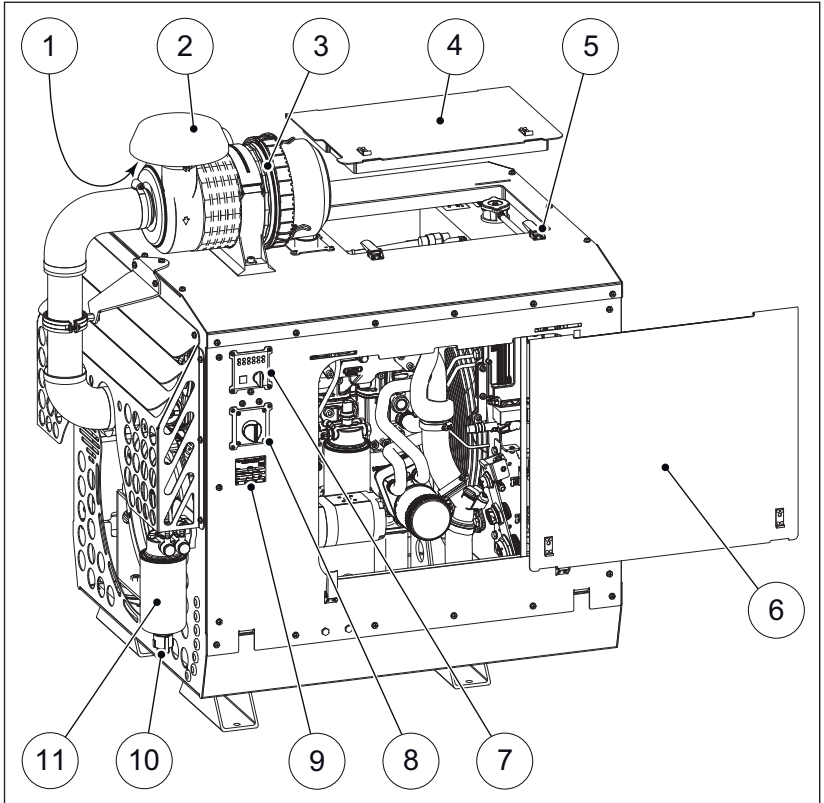

NOTICE





The Silent Pack is an Open Power Unit (OPU) that is surrounded by a noise and weather protection capsule. The maintenance covers (4) and (6) can be removed for daily maintenance work. The individual maintenance positions are shown on the figures of the OPU.

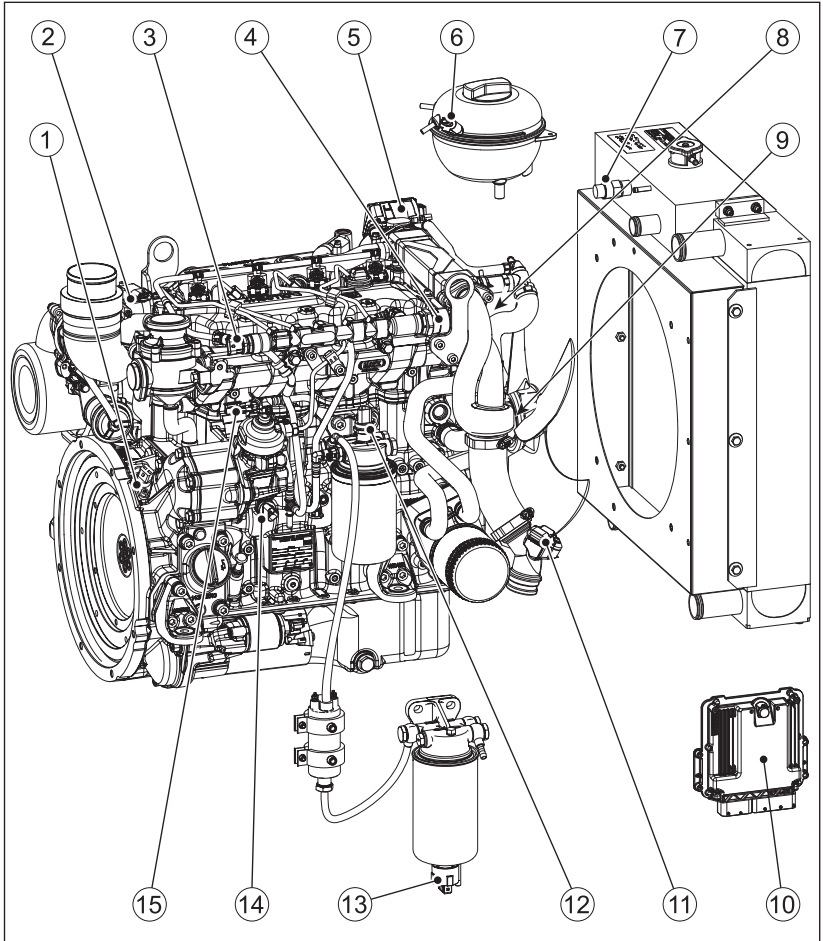

1	Intake opening for combustion air
2	Rain cap
3	Air filter (optional)
4	Top maintenance cover
5	Clamp-type fastener
6	Side maintenance cover
7	HATZ instrument box

8	Speed adjustment
9	Engine type plate
10	Drain plug with integrated water level sensor
11	Fuel prefilter

Components of the electronic engine control unit

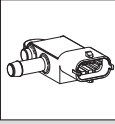
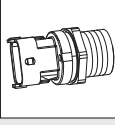
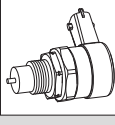
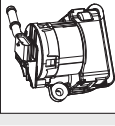
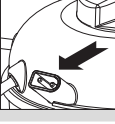
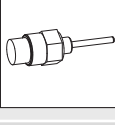

Pos.	Designation	Figure
1	Crankshaft speed sensor	

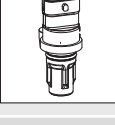
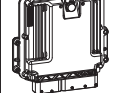
Pos.	Designation	Figure
2	Air filter differential pressure sensor	
3	Rail pressure sensor	
4	Rail pressure control valve	
5	EGR valve	
6	Coolant level sensor (integrated in external expansion tank)	
7	Coolant level sensor (for radiator with integrated expansion tank)	
8	Coolant temperature sensor	
9	Camshaft speed sensor	
10	Ambient pressure sensor (integrated in the engine control unit)	

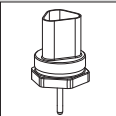
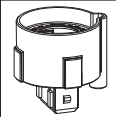
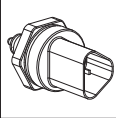
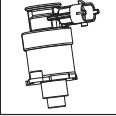
Pos.	Designation	Figure
11	Charge air pressure and charge air temperature sensor	
12	Low fuel pressure and fuel temperature sensor	
13	Water level sensor	
14	Oil pressure and oil temperature sensor	
15	Metering unit on the high pressure pump	

5.2 HATZ instrument box

Overview

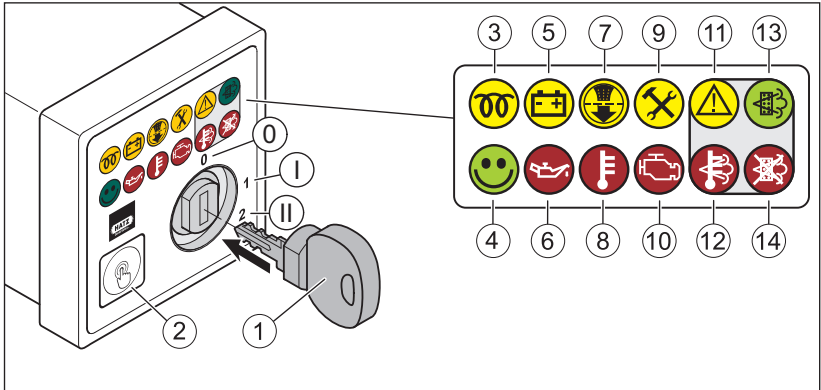









1	Starting key
2	Pushbutton
3	Pre-glow indicator
4	Operating indicator
5	Charge control
6	Oil pressure indicator
7	Air filter service indicator
8	Engine temperature indicator
9	Maintenance interval indicator
10	Engine fault
11 - 14	Faults in the area of the exhaust emission after-treatment system (not activated)
Ignition lock	
0	Off
I	Operation
II	Starting





Indicators

The function of all indicators is checked when the starting key is turned. They flash or light up for different times. If there is a fault, the applicable indicator does not go out after the engine start or it lights up again during operation.

Explanation of symbols

Symbol	Meaning
	<p>Pushbutton The pushbutton fulfills the following functions:</p> <ul style="list-style-type: none"> ▪ Request flashing code for troubleshooting. If the "Engine fault" indicator lights or flashes, the relevant flashing code can be requested for fault diagnosis. To do so, proceed as follows: <ul style="list-style-type: none"> – Turn the starting key to the "0" position and wait until the engine comes to a stop. – After the engine has stopped, immediately turn the starting key to the "1" position. – After the pushbutton has been pressed (maximum 2 seconds), the flashing code is output on the indicator for engine fault. For the flashing code table, see section 9.2 <i>Flash code table for engine faults</i>, page 113. ▪ Reset the maintenance interval indicator. (see section 8.2.18 <i>Resetting the maintenance interval indicator</i>, page 109).
	Warning and indicator lamps:
	<p>Pre-glow indicator Lights at temperatures below 30 °C. Start the engine when the indicator has gone out.</p>
	<p>Operating indicator Lights up during operation when there is no engine fault.</p>
	<p>Charge control Fault in the alternator or alternator charging circuit. The battery is no longer charged. Eliminate the fault immediately.</p>
	<p>Oil pressure indicator Engine oil pressure too low. Danger of engine damage. Stop the engine immediately and check the oil level (see section 7.5 <i>Check the oil level</i>, page 62). Contact HATZ Service if the oil level is correct.</p>







Symbol	Meaning
	<p>Air filter service indicator</p> <ul style="list-style-type: none"> ▪ lights: Clean or renew the filter cartridge at the next opportunity. ▪ flashes + engine fault flashes: Immediately clean or replace the filter cartridge. <p>For more information, see section 8.2.16 <i>Servicing the air filter (optional)</i>, page 104.</p>
	<p>Engine temperature indicator</p> <ul style="list-style-type: none"> ▪ lights: High coolant temperature. Operate engine at reduced load. Stop the engine if the engine temperature indicator has not gone out after 5 minutes. ▪ lights + engine fault flashes: Coolant temperature is inadmissibly high. Switch off the engine immediately! Danger of engine damage. <p>For details of troubleshooting, see section 9.1 <i>Troubleshooting</i>, page 110.</p>
	<p>Maintenance interval indicator</p> <p>This indicator lights when the 500-hour maintenance visit is due. After completion of maintenance work, reset the maintenance interval indicator (see section 8.2.18 <i>Resetting the maintenance interval indicator</i>, page 109).</p>

Symbol	Meaning
	<p>Engine fault This indicator lights up or flashes if there are engine faults. A flashing code can be requested for fault diagnosis (see <i>Pushbutton</i> symbol). Depending on the engine specification, the engine controller reacts as follows in case of a fault:</p> <ul style="list-style-type: none"> ▪ Emergency operation The engine switches to emergency operation. In this situation, the available engine torque is reduced and the speed is limited to max. 1900 rpm. WARNING! To avoid secondary damage, the engine may only be operated in emergency mode for a very short period, e.g. to move the equipment away from a critical location. Avoid staying in the vicinity of the running engine if possible. Switch off the engine and correct the fault promptly or contact a HATZ service center. ▪ Engine stop The engine switches off automatically. ▪ Warning lamp Only the engine fault indicator calls attention to a fault.
	Not activated.
	Not activated.
	Not activated.
	Not activated.

6 Transport, assembly and commissioning

6.1 Transport

Safety notes

 WARNING	
	<p>Danger of injury from improper lifting and transport.</p> <p>Danger of crushing from the engine falling or tipping.</p> <ul style="list-style-type: none"> ▪ The machine may only be lifted using the lifting points (1). ▪ Before lifting the engine, check the lifting eyes for deformation. Lifting with deformed lifting eyes is not permitted. Renew any deformed lifting eyes. ▪ Only use a suitable hoist with a sufficient carrying capacity. ▪ Always use all lifting eyes for lifting. ▪ Do not remain under suspended loads.
 CAUTION	
	<p>Only use the lifting eye for transporting the engine.</p> <p>Do not use for lifting the entire machine.</p>
 CAUTION	
	<p>Danger of injury from overloading the body.</p> <p>Lifting the machine to transport it or to move it to another location can lead to injuries (of the back, for example).</p> <ul style="list-style-type: none"> ▪ Only lift the machine with a hoist.
NOTICE	
	<p>Danger of environmental damage from leaking fluid.</p> <p>If the machine is tilted, engine oil and fuel can run out.</p> <ul style="list-style-type: none"> ▪ Only transport the machine in an upright position.

Access to the lifting eyes with the Silent Pack

Safety note

CAUTION

Danger of engine damage due to foreign bodies.

If the air intake hose is disconnected from the air filter, there is a danger that foreign bodies can enter the air intake hose. These are sucked in during operation and can lead to engine damage as a consequence.

- Make sure that no dirt or other foreign bodies enter the air intake hose.

Overview

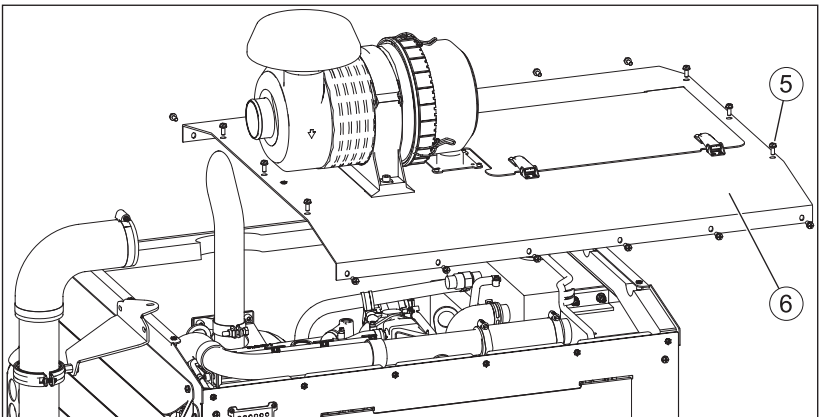
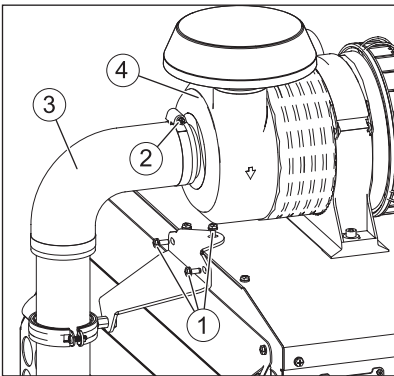

1	Fixing screws for retaining plate
2	Hose clamp

3	Air intake hose
4	Air filter
5	Fixing screws for the top part of the capsule (18 pieces)
6	Top part of the capsule

Procedure

Step	Activity
1	Unscrew the fixing screws (1).
2	Undo the hose clamp (2) and remove the air intake hose (3) from the air filter (4).
3	Unscrew the fixing screws (5).
4	Top part of the capsule
5	Mount all parts again after completing the transport activities. <i>Do not forget:</i> Tighten the hose clamp (2)!

Lifting points (engines with 2 lifting eyes)

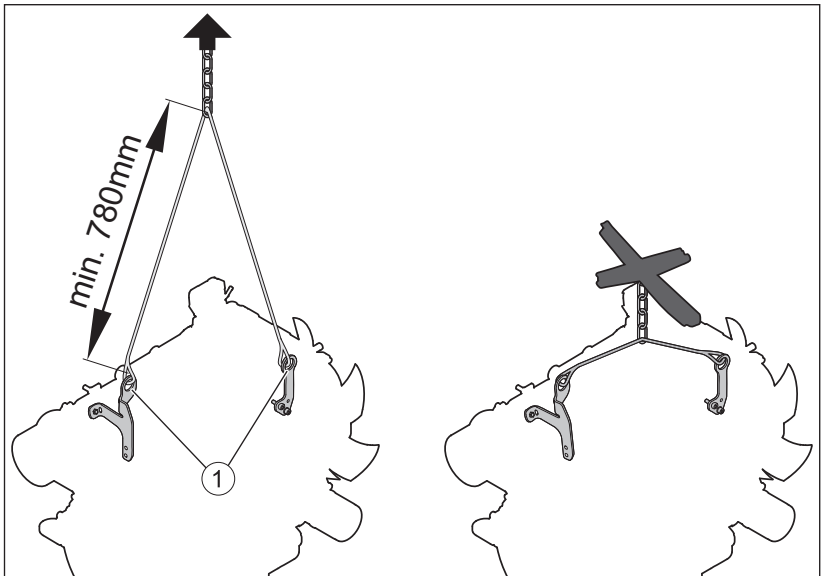

1 Lifting points

Lifting points (engines with 3 lifting eyes)

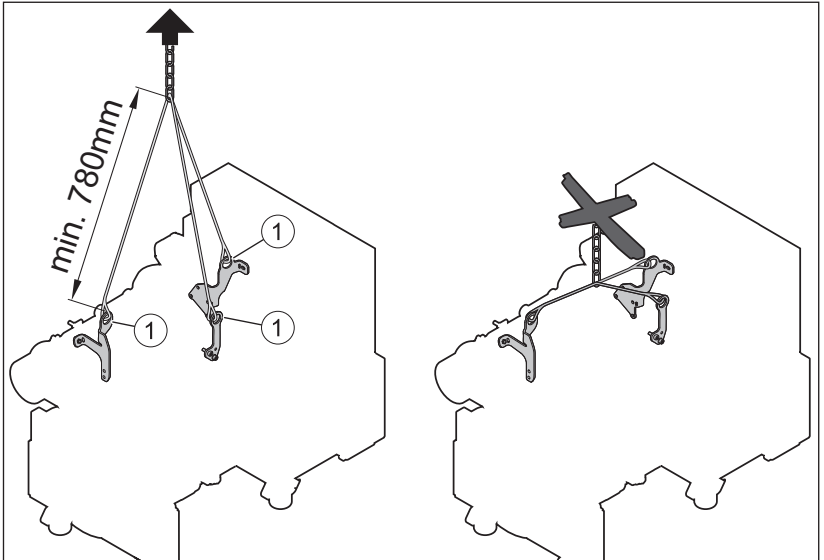

1 Lifting points

Transport conditions

- When transporting the machine, follow the safety instructions.
- When transporting, follow the applicable safety and accident prevention regulations of the trade associations.
- After delivery, check the machine for completeness and transport damage.
- Only transport the machine when it is switched off and has cooled down.
- If you have questions on transporting the machine, please contact your nearest **HATZ service station**. For contact data, see chapter 1 *Impressum*, page 5 or www.hatz-diesel.com.

6.2 Installation notes

HATZ diesel engines are efficient, robust, and have a long service life. Therefore, they are usually installed in machines that are used for commercial purposes.

The machine manufacturer must follow the applicable regulations regarding machine safety – the engine is a part of a machine.

Depending on the use and installation of the engine, it may be necessary for the machine manufacturer and machine user to install safety equipment to prevent inappropriate use. Note the following:

- Parts of the exhaust gas system and the engine surface become hot during operation and may not be touched until they cool down after the engine is switched off.
- Incorrect cable connections and incorrect operation of the electrical equipment can lead to sparking and must be avoided.
- After the engine is installed in the machine, rotating parts must be protected against contact.
HATZ safety equipment is available for the belt drive of the cooling fan and alternator.
- Comply with all notices and warning labels on the engine and keep them in a legible condition. If a label should become detached or difficult to read, it must be replaced promptly. For this purpose, contact your nearest **HATZ service station**.
- Any improper modification of the engine will result in a loss of liability coverage for resulting damage.



Only regular maintenance, as specified in this manual, will maintain the operating readiness of the engine.

The **assembly instructions** contain important information on how to safely assemble the engine. They are available from any **Hatz service station**.

If you have any questions, please contact your nearest **HATZ service station** before commissioning the engine.

6.3 Preparations for commissioning

- Check the delivered parts for completeness, damage, and other noticeable issues.
- Ensure that the setup location is adequately ventilated.

 DANGER	
	<p>Danger to life from inhaling exhaust gases.</p> <p>Toxic engine exhaust gases can lead to loss of consciousness and even death in closed-off and poorly ventilated rooms.</p> <ul style="list-style-type: none"> ▪ Never operate the machine in closed-off or poorly ventilated rooms. ▪ Do not breathe in the exhaust gases.

6.4 Filling engine oil (first filling)

Engines are normally delivered without an engine oil filling.

Safety note

CAUTION

Danger of later engine damage.

- Operating the engine with an oil level below the **min.** mark or above the **max.** mark can lead to engine damage.
- When checking the oil level, the engine must be horizontal and have been switched off for a few minutes.

Overview

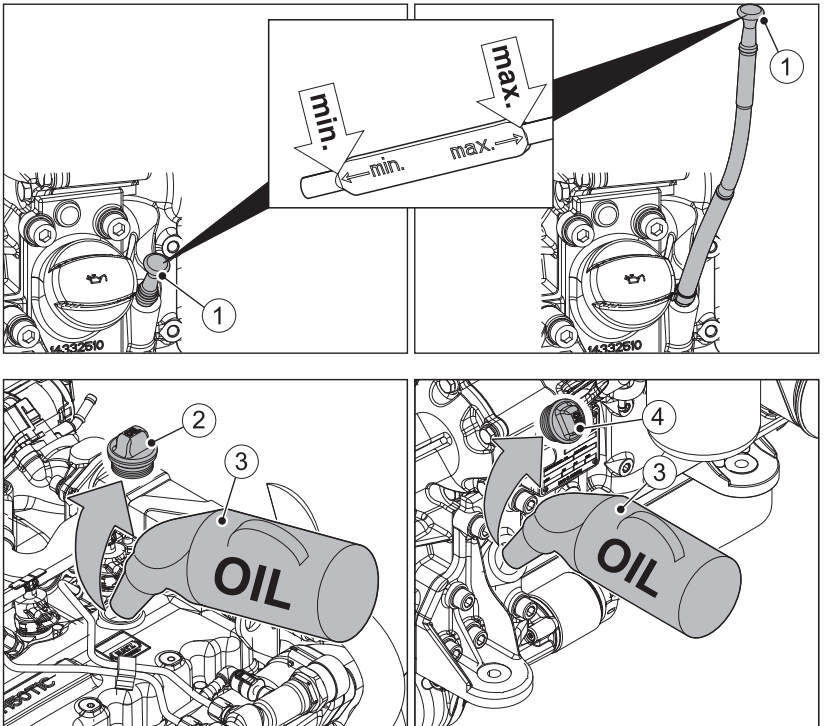



1	Dipstick (depending on the model)
2	Oil filler plug, top
3	Oil refilling container
4	Oil filler plug, bottom

Procedure

Step	Activity
1	Pull out the dipstick (1) and clean it.
2	Depending on accessibility, unscrew oil filler plug (2) or (4).
3	Fill with engine oil. For the specification and viscosity, see section 4.3 <i>Engine oil</i> , page 23. For the filling quantity, see section 4.1 <i>Engine information and filling quantities</i> , page 21.
4	Reinsert the dipstick.
5	Pull out the dipstick and check the oil level.
6	If required, top up the engine oil to the max. mark.
7	Reinsert the dipstick.
8	Screw in the oil filler plug.

6.5 Filling the cooling system**Safety notes**

 CAUTION	
 	<p>Danger of burns.</p> <p>There is a danger of burns when working on a hot cooling system. The cooling system is pressurized when the engine is hot.</p> <ul style="list-style-type: none"> ▪ Let the engine cool. ▪ Wear safety gloves.
CAUTION	
	<p>Danger of later engine damage.</p> <ul style="list-style-type: none"> ▪ Operating the engine with a coolant level below the MIN. mark can lead to engine damage. ▪ When checking the coolant level, the engine must be horizontal and switched off.

Overview

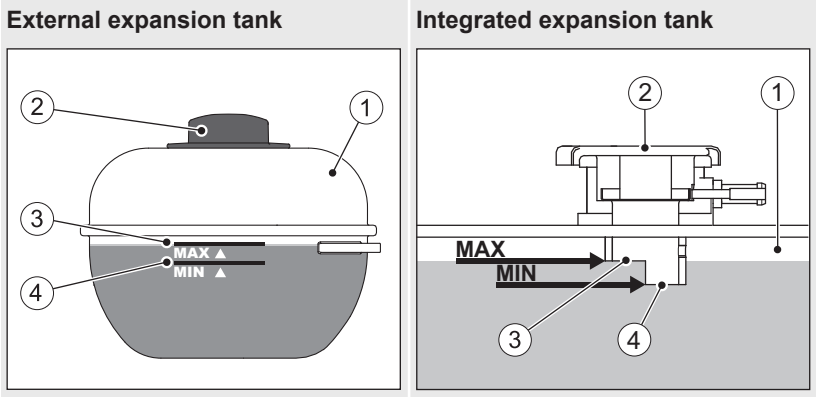

1	Expansion tank for coolant
2	Sealing cap
3	MAX - Maximum coolant level
4	MIN - Minimum coolant level





Procedure

Step	Activity
1	Open the sealing cap (2).
HATZ radiator with integrated expansion tank	
2	Top up the coolant to the edge (3) of the pipe section. For preparation of the coolant, see section 4.4 <i>Coolant</i> , page 24.
HATZ radiator with external expansion tank	
2	Top up the coolant to the MAX mark on the expansion tank. For preparation of the coolant, see section 4.4 <i>Coolant</i> , page 24.
3	Tighten the sealing cap (2) all the way by hand.
4	Start the engine (see chapter 7 <i>Operation and use</i> , page 56).
5	Warm up the engine until the coolant has reached a temperature of approx. 85 °C. Above this temperature the coolant is pumped through the entire cooling system and forces out remaining air bubbles.
6	Switch off the engine and let it cool down completely (see chapter 7 <i>Operation and use</i> , page 56).

Step	Activity
7	Check the coolant level again. The coolant must be seen between the MIN and MAX mark; for a warm engine the level can also be slightly above the MAX mark.
8	Check the cooling system for leaks, retighten the hose clips if necessary (see section 8.2.5 <i>Checking the cooling system</i> , page 75).

6.6 Starting the engine for the first time or after a fuel filter replacement

Safety notes

 DANGER	
	<p>Danger to life from inhaling exhaust gases.</p> <p>Toxic engine exhaust gases can lead to loss of consciousness and even death in closed-off and poorly ventilated rooms.</p> <ul style="list-style-type: none"> ▪ Never operate the machine in closed-off or poorly ventilated rooms. ▪ Do not breathe in the exhaust gases.
 CAUTION	
	<p>Health hazard due to inhalation of flue gas.</p> <p>To protect exposed metal parts against corrosion, the parts concerned are coated with a protective wax. When the engine is started for the first time, this protective wax evaporates on hot components. This can lead to the generation of smoke for a brief period.</p> <ul style="list-style-type: none"> ▪ Do not inhale flue gas. ▪ Ensure sufficient ventilation.
CAUTION	
	<p>Danger of engine damage from the use of starting fluid.</p> <ul style="list-style-type: none"> ▪ Engine damage from the use of starting fluid can lead to uncontrolled ignition. ▪ Engine damage from uncontrolled ignition. ▪ Never use starting fluid.

NOTICE

See also starting instructions in the documentation for the complete machine.

Before starting

Before starting the engine, several tests need to be performed to ensure the machine is working properly.

Step	Test
1	The machine is standing securely and on a level surface.
2	The installation location is adequately ventilated.
3	There is a sufficient amount of fuel in the fuel tank (see the chapter 7.6 <i>Refueling</i> , page 64).
4	There is a sufficient amount of engine oil in the engine housing (see the chapter 7.5 <i>Check the oil level</i> , page 62).
5	There is a sufficient amount of coolant in the expansion tank (see the chapter 8.2.5 <i>Checking the cooling system</i> , page 75).
6	Radiator and radiator hoses are free from leaks (see the chapter 8.2.5 <i>Checking the cooling system</i> , page 75).
7	No persons are located in the danger zone of the engine or machine.
8	All safety equipment is in place.

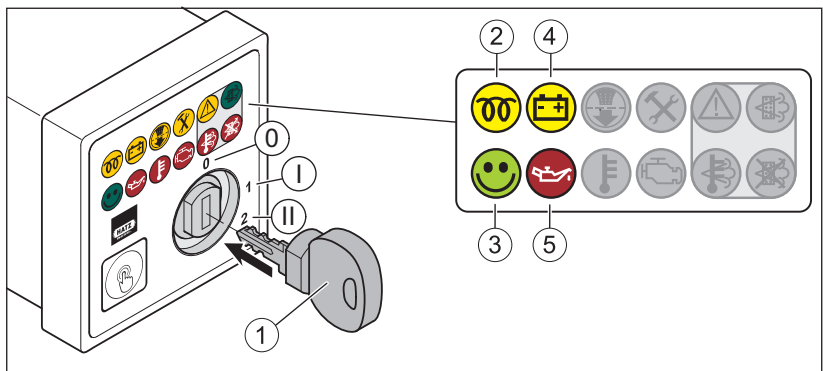
Overview — HATZ instrument boxes

1	Starting key
2	Pre-glow indicator

3	Operating indicator
4	Charge control
5	Oil pressure indicator
Ignition lock	
0	Off
I	Operation
II	Start

NOTICE	
	<p>For further details on the instrument box, see section 5.2 <i>HATZ instrument box</i>, page 40.</p>

Procedure

NOTICE	
	<ul style="list-style-type: none"> ▪ Start for max. 20 seconds. If the engine is still not running after that, turn the starting key back to position "0" and eliminate the cause (see section 9.1 <i>Troubleshooting</i>, page 110). ▪ Turn the starting key to position "0" every time you want to start the engine. The starter protection module prevents the starter from engaging while the engine is running and becoming damaged.

Step	Activity
Venting the fuel system	
1	Insert the starting key all the way and turn to position "I". Depending on the model, the following indicators light up: <ul style="list-style-type: none"> ▪ Pre-glow indicator (2) ▪ Charge control (4) ▪ Oil pressure indicator (5)
2	Leave the starting key at position "I" until you hear the electrical fuel feed pump switch off (approx. 30 seconds).
3	Turn the starting key back to position "0". <i>Note:</i> Carry out steps 2 and 3 several times to press the air out of the fuel system.

Step	Activity
Starting the engine	
4	Turn the starting key to position "I" again.
5	If the pre-glow indicator goes out, turn the starting key to position "II".
6	As soon as the engine is running, release the starting key. <ul style="list-style-type: none"> ▪ The starting key springs back to position "I" and remains in this position during operation. ▪ The charge control (4) and oil pressure indicator (5) go out. ▪ The operating indicator (3) lights up and signals that there is no engine fault.

NOTICE



- In case of irregularities, switch off the engine immediately.
- Identify the fault and eliminate it.
- For details of troubleshooting, see chapter 9.1 *Troubleshooting*, page 110.

7 Operation and use

7.1 Safety notes

NOTICE



Comply with the safety chapter!

Follow the basic safety instructions in chapter 3 *Safety*, page 7.



WARNING



Danger of injury from damage and defects on the machine.

- Do not take the machine into service if damage has been localized and identified.
- Replace faulty components.



WARNING



Danger of injury from failure to follow the operating instructions and from performing unauthorized tasks on the machine.

- Define the responsibilities of the personnel taking the machine into service.
- Replace faulty machine parts immediately.
- Check the installation conditions when the machine is first taken into service and after the machine has been inactive for a lengthy period.



WARNING



Danger of injury during emergency operation due to engine damage and faults.

The engine fault indicator lights up or flashes.

- To avoid secondary damage, the engine may only be operated in emergency mode for a very short period, e.g. to move the equipment away from a critical location. For details on engine faults and fault diagnosis, see chapter 5.2 *HATZ instrument box*, page 40.
- Avoid staying in the vicinity of the running engine if possible.
- Switch off the engine and correct the fault promptly or contact a HATZ service center.

CAUTION**Danger of engine damage from low load operation.**

Operating the engine at no load or at very low load for an extended period can impair the running characteristics of the engine.

- Make sure that the engine load is at least 15 %.
- Before switching off the engine following low load operation, briefly operate it at a considerably higher load.

7.2 Performing tests**Before starting**



Before starting the engine, several tests need to be performed to ensure the machine is working properly.

Procedure

Step	Test
1	The machine is standing securely and on a level surface.
2	The installation location is adequately ventilated.
3	There is a sufficient amount of fuel in the fuel tank (see the chapter 7.6 <i>Refueling</i> , page 64).
4	There is a sufficient amount of engine oil in the engine housing (see the chapter 7.5 <i>Check the oil level</i> , page 62).
5	There is a sufficient amount of coolant in the expansion tank (see the chapter 8.2.5 <i>Checking the cooling system</i> , page 75).
6	Radiator and radiator hoses are free from leaks (see the chapter 8.2.5 <i>Checking the cooling system</i> , page 75).
7	No persons are located in the danger zone of the engine or machine.
8	All safety equipment is in place.

7.3 Starting the engine

Safety notes

 DANGER	
	<p>Danger to life from inhaling exhaust gases.</p> <p>Toxic engine exhaust gases can lead to loss of consciousness and even death in closed-off and poorly ventilated rooms.</p> <ul style="list-style-type: none"> ▪ Never operate the machine in closed-off or poorly ventilated rooms. ▪ Do not breathe in the exhaust gases.
CAUTION	
	<p>Danger of engine damage from the use of starting fluid.</p> <ul style="list-style-type: none"> ▪ Engine damage from the use of starting fluid can lead to uncontrolled ignition. ▪ Engine damage from uncontrolled ignition. ▪ Never use starting fluid.
NOTICE	
	<p>See also starting instructions in the documentation for the complete machine.</p>

Overview — HATZ instrument boxes

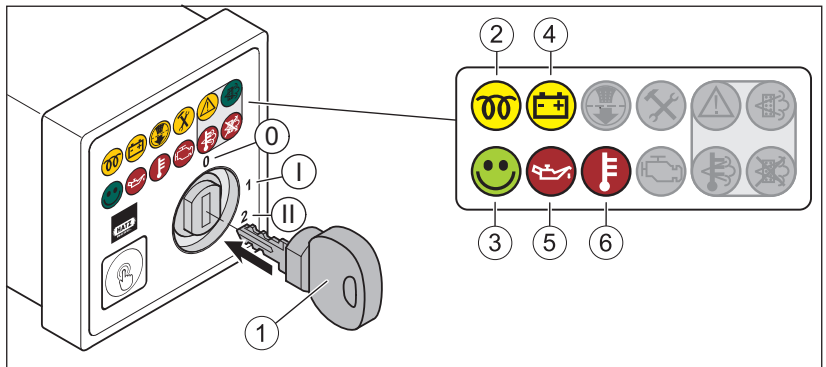

1	Starting key
2	Pre-glow indicator
3	Operating indicator

4	Charge control
5	Oil pressure indicator
6	Engine temperature indicator
Ignition lock	
0	Off
I	Operation
II	Start

NOTICE



For further details on the instrument box, see section 5.2 HATZ instrument box, page 40.

Procedure

NOTICE



- Start for max. 20 seconds. If the engine is still not running after that, turn the starting key back to position "0" and eliminate the cause (see section 9.1 Troubleshooting, page 110).
- Turn the starting key to position "0" every time you want to start the engine. The starter protection module prevents the starter from engaging while the engine is running and becoming damaged.

Step	Activity
1	<p>Insert the starting key all the way and turn to position "I".</p> <p>Depending on the model, the following indicators light up:</p> <ul style="list-style-type: none"> ▪ Pre-glow indicator (2) ▪ Charge control (4) ▪ Oil pressure indicator (5) <p><i>NOTE:</i> If the optional engine temperature indicator (6) lights up, the coolant temperature is inadmissibly high. Do not start the engine; eliminate the cause.</p> <p>When the pre-glow indicator goes out, continue with step 2.</p>
2	Turn the starting key to position "II".

Step	Activity
3	<p>As soon as the engine is running, release the starting key.</p> <ul style="list-style-type: none"> ▪ The starting key springs back to position "I" and remains in this position during operation. ▪ The charge control (4) and oil pressure indicator (5) go out. ▪ The operating indicator (3) lights up and signals there is no engine fault.

NOTICE	
	<ul style="list-style-type: none"> ▪ In case of irregularities, switch off the engine immediately. ▪ Identify the fault and eliminate it. ▪ For details of troubleshooting, see chapter 9.1 <i>Troubleshooting</i>, page 110.

7.4 Switching off the engine

Safety notes

 CAUTION	
--	--

	<p>Danger of injury from unauthorized access.</p> <p>There is a danger of injury if unauthorized persons handle the machine.</p> <ul style="list-style-type: none"> ▪ Protect the starting key against unauthorized access during breaks in operation or after completing work.
---	---

CAUTION	
----------------	--

	<p>Danger of engine damage from overheating.</p> <p>The switching off of the engine after high engine load or at high cooling liquid temperature (engine temperature indicator lights up) can lead to engine damage due to heat accumulation.</p> <ul style="list-style-type: none"> ▪ Allow the engine to cool down for approx. 5 min at reduced speed and load.
--	---

NOTICE	
---------------	--

	<p>Danger of exhaustive battery discharge.</p> <ul style="list-style-type: none"> ▪ When the machine is switched off, always turn the starting key to position "0" or else the battery may become fully discharged.
---	---

NOTICE

See also instructions in the documentation for the complete machine.

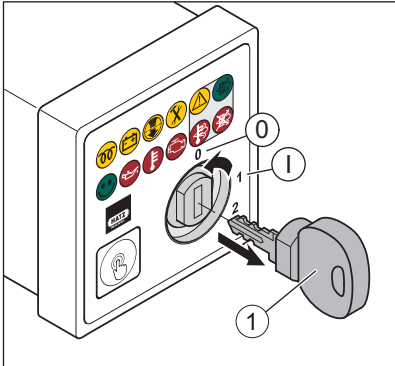
Overview — HATZ instrument boxes



1	Starting key
Ignition lock	
0	Off
1	Operation

Procedure

Step	Activity
1	Turn the starting key (1) to position "0". The engine switches off. All indicator lamps go out after approx. 10 seconds.
2	Remove the starting key.

7.5 Check the oil level

Safety notes

 CAUTION	
 	<p>Danger of burns.</p> <p>There is a danger of burns when working on a hot engine.</p> <ul style="list-style-type: none"> Wear safety gloves.

CAUTION	
	<p>Danger of later engine damage.</p> <ul style="list-style-type: none"> Operating the engine with an oil level below the min. mark or above the max. mark can lead to engine damage. When checking the oil level, the engine must be horizontal and have been switched off for a few minutes.

Overview

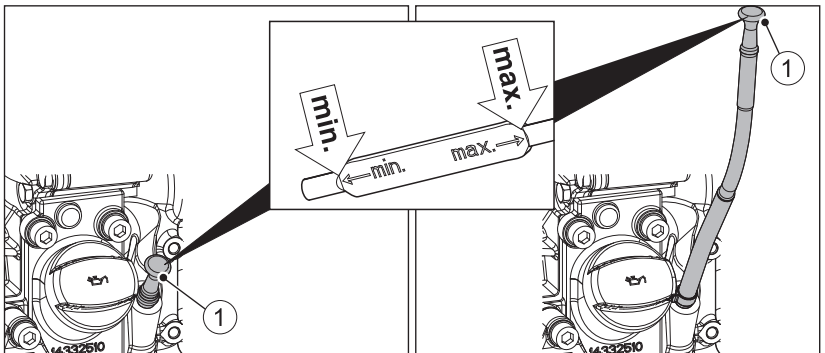

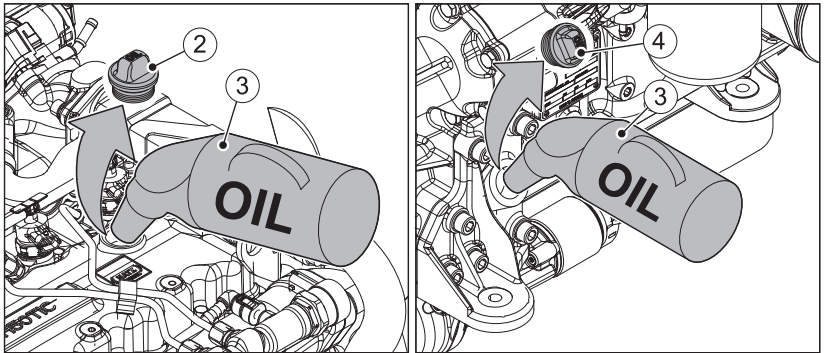

1	Dipstick (depending on the model)
2	Oil filler plug, top
3	Oil refilling container
4	Oil filler plug, bottom







Procedure — Checking oil level/adding oil

Step	Activity
1	Switch off the engine and wait several minutes for the engine oil to collect in the crankcase. Engine must be level.
2	Remove contamination on the engine in the area of the dipstick (1).
3	Pull out the dipstick and clean it.
4	Reinsert the dipstick.
5	Pull out the dipstick and check the oil level.
6	If the oil level is close to the min. mark, add engine oil to the max. mark. For the specification and viscosity, see chapter 4.3 <i>Engine oil</i> , page 23.
7	Reinsert the dipstick.

7.6 Refueling

This diesel engine is intended for installation in a machine or for assembly with other machines to form a machine and does not have its own fuel tank. Follow the instructions from the manufacturer and comply with the following safety information.



Safety notes

 DANGER	
 	<p>Fire hazard from fuel.</p> <p>Leaked or spilled fuel can ignite on hot engine parts and cause serious burn injuries.</p> <ul style="list-style-type: none"> ▪ Only refuel when the engine is switched off. ▪ Never refuel in the vicinity of open flames or sparks that can cause ignition. ▪ Do not smoke. ▪ Do not spill fuel.
 CAUTION	
	<p>Danger of environmental damage from spilled fuel.</p> <p>Do not overfill the fuel tank and do not spill fuel.</p> <ul style="list-style-type: none"> ▪ Collect any leaking fuel and dispose of it according to local environmental regulations.
CAUTION	
	<p>Engine damage from using low quality fuel.</p> <p>The use of fuel that does not meet the specifications can lead to engine damage.</p> <ul style="list-style-type: none"> ▪ Only use the fuel specified in chapter 4.5 <i>Fuel</i>, page 29. ▪ The use of fuel that does not meet specifications requires approval by Motorenfabrik HATZ (main plant).
NOTICE	
	<p>Never run the tank empty if possible, as otherwise air can enter the fuel system. This can lead to damage to the injection system.</p> <p>If the tank runs dry nevertheless, the fuel system must be drained prior to the next start (see section 6.6 <i>Starting the engine for the first time or after a fuel filter replacement</i>, page 52).</p>

8 Maintenance

8.1 General maintenance instructions

Safety notes

 WARNING	
	<p>Danger of injury from failure to follow the operating instructions and from performing unauthorized tasks on the machine.</p> <ul style="list-style-type: none"> ▪ Follow all instructions. ▪ Do not perform activities for which no qualification is available. Contact properly trained personnel if necessary.

NOTICE	
	<p>Comply with the safety chapter!</p> <p>Follow the basic safety instructions in chapter 3 <i>Safety</i>, page 7.</p>

- Maintenance tasks may only be performed by trained personnel.
- Accident prevention measures must be in accordance with the local accident prevention regulations.
- Perform setting and maintenance work at the specified intervals.
- Replace faulty machine parts as soon as possible.
- Always wear personal protection equipment.
- Only use fully functional tools.
- Installation of unsuitable spare parts can lead to problems. We cannot accept responsibility for direct damage or secondary damage that results from this. We therefore recommend the use of **Hatz original spare parts**.
- Closely adhere to the maintenance conditions prescribed in this manual.
- Only make changes to the machine in agreement with the manufacturer.
- Only perform maintenance work when the engine is stopped.
- Protect the starting key from unauthorized access.
- Disconnect the negative battery terminal before carrying out maintenance work.
- Adhere to legal regulations when handling and disposing of used oil, filters, coolants, and cleaning agents.
- After completing maintenance work, check that all tools, bolts, aids, and other objects are removed from the machine, and that all safety equipment has been replaced.

- Before starting, ensure that no persons are located in the danger zone of the engine or machine.



Performance of maintenance work

The entire machine is designed to be maintenance friendly. Parts that require maintenance are easily accessible.

- Perform maintenance work faithfully at the specified intervals to prevent premature wear of the machine.
- Follow the notice and warning labels on the machine.
- Always retighten screw connections loosened during maintenance work.
- After the necessary maintenance and repair work is completed, perform a function test (test run).
- For maintenance work that is not listed and described in the maintenance documentation, please contact your nearest **HATZ service station**.

8.2 Maintenance work



Safety note

 CAUTION	
	<p>Danger of injury if maintenance instructions are not followed.</p> <ul style="list-style-type: none"> ▪ Only perform maintenance when the engine is switched off. ▪ Protect the starting key against unauthorized access. ▪ Disconnect the negative terminal of the battery. ▪ After the maintenance work is completed, ensure that all tools have been removed from the machine.

8.2.1 Maintenance plan

In new and generally overhauled engines, after 50 operating hours:

- Change the engine oil and oil filter. See chapter 8.2.6 *Changing the engine oil and oil filter*, page 78.
- Check the screw connections (do not retighten the screws for attaching the cylinder head). See section 8.2.12 *Checking the screw connections*, page 97.





Symbol	Maintenance interval	Maintenance activity/check	Section
	Every 8–15 operating hours or every day before starting	Check the oil level.	<i>7.5 Check the oil level, page 62</i>
		Check the intake area of the combustion air.	<i>8.2.3 Checking the intake area of the combustion air, page 72</i>
		Check the radiator fins for dirt accumulation.	<i>8.2.4 Checking the radiator fins for dirt accumulation, page 74</i>
		Check the cooling system	<i>8.2.5 Checking the cooling system, page 75</i>
	Every 500 operating hours or every 2 years	Change the engine oil and oil filter ¹⁾	<i>8.2.6 Changing the engine oil and oil filter, page 78</i>
		Change the fuel prefilter ¹⁾	<i>8.2.14 Changing the fuel prefilter, page 99</i>
		Replace the main fuel filter ¹⁾	<i>8.2.15 Changing the main fuel filter, page 101</i>
		Check the poly v belt ¹⁾	<i>8.2.8 Checking the poly v belt, page 87</i>
		Change the oil separator of the crankcase ventilation ¹⁾	<i>8.2.11 Changing the oil separator of the crankcase ventilation, page 96</i>
		Check the screw connections ¹⁾	<i>8.2.12 Checking the screw connections, page 97</i>
		Clean the engine ¹⁾	<i>8.2.7 Engine cleaning, page 84</i>
	Every 500 operating hours or when indicated, at least every 2 years	Change the air filter cartridge	<i>8.2.16 Servicing the air filter (optional), page 104</i>

Symbol	Maintenance interval	Maintenance activity/check	Section
	When indicated, at least every 2 years	Drain the water separator ¹⁾	<i>8.2.13 Draining the water separator, page 98</i>
	Every 4 years	Change the coolant	<i>8.2.17 Changing coolant, page 106</i>
	If necessary, but every 3,000 operating hours at the latest	Replace the poly v belts	<i>8.2.10 Replacing the poly v belts, page 92</i>
	Every 4,000 operating hours	Clean the entire exhaust gas recirculation section (EGR pre-cooler, EGR valve, EGR main cooler as well as EGR mixing nozzle) (to be carried out by a trained specialist)	

¹⁾ Maintenance according to maintenance interval or after 2 years depending on which criteria is first.

8.2.2 Additional work on the Silent Pack

Safety notes

 WARNING	
	<p>Danger of injury from rotating parts.</p> <p>Touching the fans or poly v belts can lead to serious injury when the engine is running.</p> <ul style="list-style-type: none"> ▪ Only operate the engine when all covers are installed.
 CAUTION	
 	<p>Danger of burns.</p> <p>There is a danger of burns when working on a hot engine.</p> <ul style="list-style-type: none"> ▪ Let the engine cool. ▪ Wear safety gloves.

CAUTION**Danger of engine damage due to foreign bodies.**

If the air intake hose is disconnected from the air filter, there is a danger that foreign bodies can enter the air intake hose. These are sucked in during operation and can lead to engine damage as a consequence.

- Make sure that no dirt or other foreign bodies enter the air intake hose.

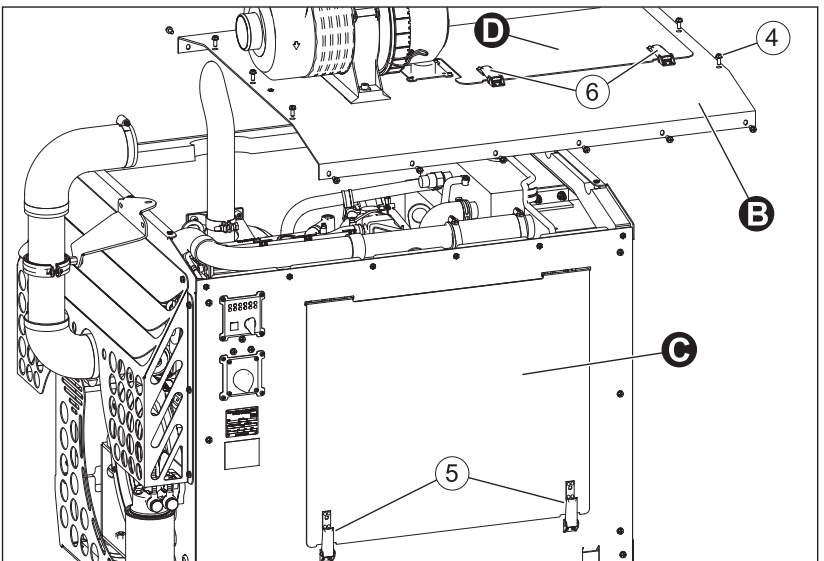
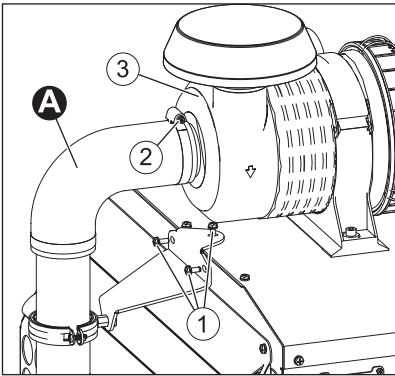
Overview

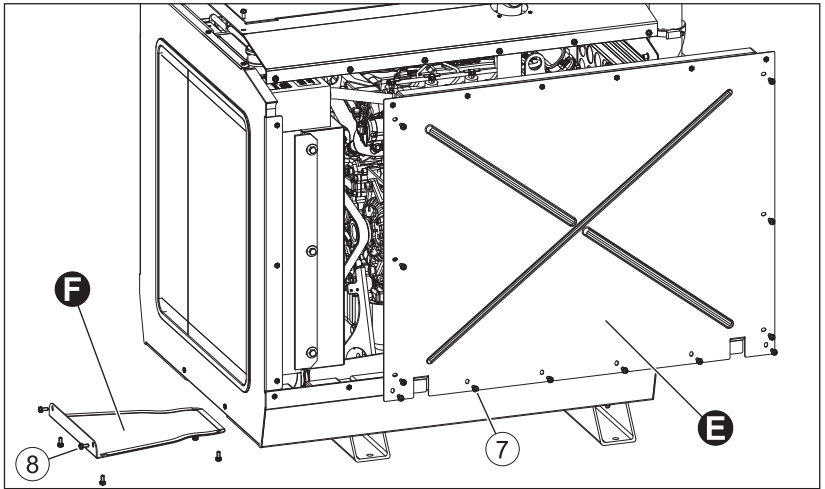

A	Air intake hose
B	Top part of the capsule
C	Control side maintenance lid
D	Top maintenance cover
E	Side panel on exhaust gas side
F	Access cover to the drain plug on the radiator
1	Fixing screws for retaining plate
2	Hose clamp
3	Air filter
4	Fastening screws for capsule fixing screws for the top part of the capsule (18 pieces)
5	Clamp-type fasteners for control side maintenance cover
6	Clamp-type fasteners for top maintenance lid
7	Fixing screws for side panel (12 pieces)
8	Fixing screws for access lid (6 pieces)

Access to the service points

With the Silent Pack, the engine is surrounded by a noise and weather protection capsule. In order to access the respective service points, the components listed in the following must be disassembled beforehand:

Maintenance step	Component disassembly
Check the oil level	C
Check the intake area of the combustion air	D
Check the cooling system	A, B, C, E
Change the engine oil and oil filter	C
Change the main fuel filter	C
Check or replace the poly v belts	A, B, E
Change the oil separator of the crankcase ventilation	A, B
Checking the screw connections	A, B, C, E
Cleaning the engine	A, B, C, E
Change coolant	D, F





Procedure

Step	Activity
Remove the air intake hose (A) from the air filter	
1	Unscrew the fixing screws (1).
2	Undo the hose clamp (2) and remove the air intake hose (A) from the air filter (3).
Remove the top part of the capsule (B)	
1	Remove the air intake hose (A) from the air filter
2	Unscrew the fixing screws (4).
3	Remove the top part of the capsule (B)
Remove the control side maintenance cover (C)	
1	Remove the maintenance cover after releasing the clamp-type fasteners (5).
Remove the top maintenance cover (D)	
1	Remove the maintenance cover after releasing the clamp-type fasteners (6).

Step	Activity
Remove the side panel on the exhaust gas side (E)	
1	Remove the top part of the capsule (B)
2	Unscrew the fixing screws (7).
3	Remove the side panel (E)
Remove the access cover (F) to the drain plug on the radiator	
1	Unscrew the fixing screws (8).
2	Remove the access cover (F).
Assembly	
1	Mount all parts again after the maintenance steps have been completed. <i>Do not forget:</i> If the air intake hose (A) has been disconnected from the air filter, tighten the hose clamp (2) again!

8.2.3 Checking the intake area of the combustion air

Safety notes

 CAUTION	
 	<p>Danger of burns.</p> <p>There is a danger of burns when working on a hot engine.</p> <ul style="list-style-type: none"> ▪ Let the engine cool. ▪ Wear safety gloves.
NOTICE	
	<p>In case of heavy contamination, shorten the maintenance intervals accordingly (see chapter 8.2.1 <i>Maintenance plan</i>, page 66).</p>

Overview (HATZ air filter)

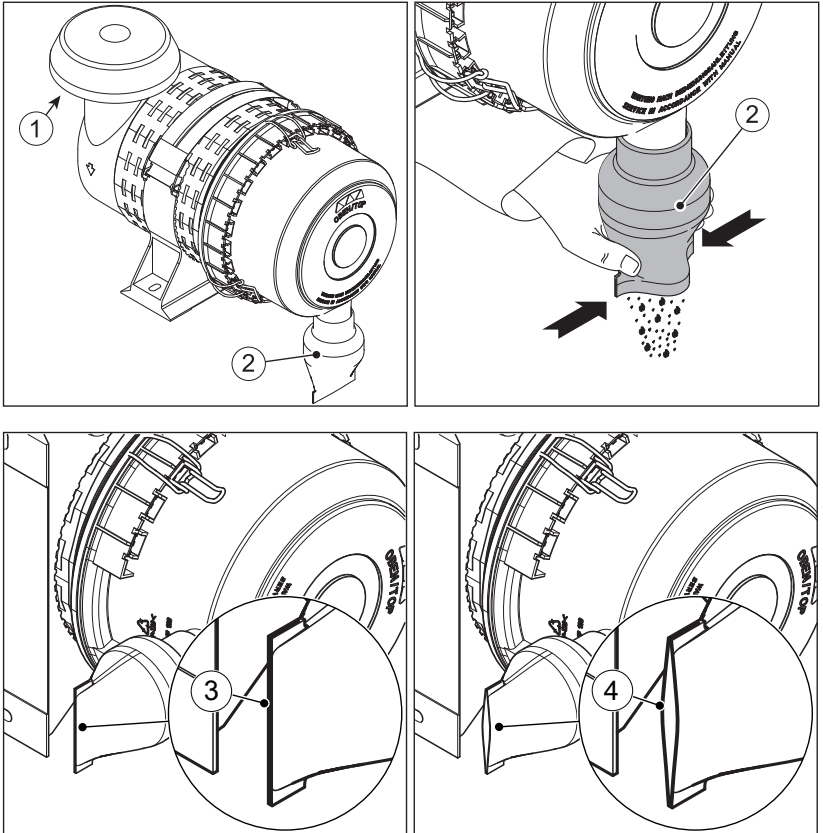

1	Intake opening for combustion air
2	Dust discharge valve
3	Rubber lips OK
4	Rubber lips deformed







Procedure

Step	Activity
1	Check the intake opening (1) for coarse contamination such as leaves, heavy dust deposits, etc., and clean if necessary.
2	Check that the dust discharge valve (2) is clear. Remove dust seals by pressing them together.

Step	Activity
3	Make sure that the rubber lips (3) run parallel to each other. The gap between the rubber lips must be a maximum of 2 mm. Deformed rubber lips (4) impair the function of the precleaner, thus shortening the maintenance interval of the air filter. Replace the dust discharge valve if required.

8.2.4 Checking the radiator fins for dirt accumulation

Safety notes

 CAUTION	
 	<p>Danger of burns.</p> <p>There is a danger of burns when working on a hot engine.</p> <ul style="list-style-type: none"> ▪ Let the engine cool. ▪ Wear safety gloves.
 CAUTION	
 	<p>Danger of injury.</p> <p>When working with compressed air, foreign bodies may fly into your eyes.</p> <ul style="list-style-type: none"> ▪ Wear safety goggles. ▪ Never direct the compressed air jet toward people or toward yourself.
CAUTION	
	<p>Danger of engine damage from overheating.</p> <p>The engine temperature indicator lights up as soon as the engine becomes inadmissibly hot.</p> <ul style="list-style-type: none"> ▪ Switch off the engine and eliminate the cause.
NOTICE	
	<p>In case of heavy contamination, shorten the maintenance intervals accordingly (see chapter 8.2.1 <i>Maintenance plan, page 66</i>).</p>

Overview

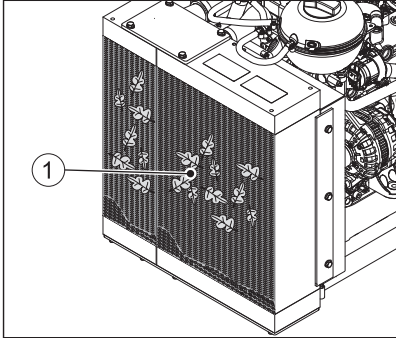





1	Radiator fins
---	---------------

Procedure

Step	Activity
1	Check the radiator fins (1) for coarse contamination such as leaves, heavy dust deposits, etc., and clean if necessary (see the chapter 8.2.7 <i>Engine cleaning</i> , page 84).

8.2.5 Checking the cooling system

Safety notes

 CAUTION	
 	<p>Danger of scalding and risk of environmental damage due to hot coolant.</p> <ul style="list-style-type: none"> ▪ Excessive coolant is blown off from the sealing cap on the expansion tank. After topping up the cooling system never move parts of your body or face close to the sealing cap. ▪ Never top up coolant above the MAX - mark on the expansion tank. ▪ Never stop escaping coolant with your bare hands.
 CAUTION	
	<p>Danger of burns.</p> <p>There is a danger of burns when working on a hot engine.</p> <ul style="list-style-type: none"> ▪ Let the engine cool before maintenance.

⚠ CAUTION



Danger of burns.

There is a danger of burns when working on a hot cooling system. The cooling system is pressurized when the engine is hot.



- Let the engine cool.
- Wear safety gloves.

CAUTION

Danger of later engine damage.

- Operating the engine with a coolant level below the **MIN.** mark can lead to engine damage.
- When checking the coolant level, the engine must be horizontal and switched off.

Overview

External expansion tank

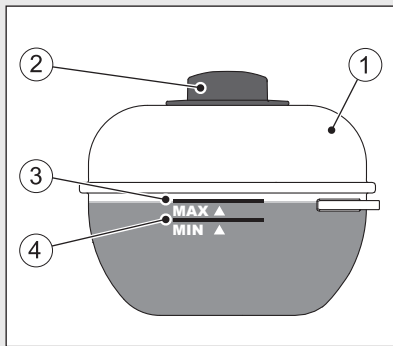

Integrated expansion tank

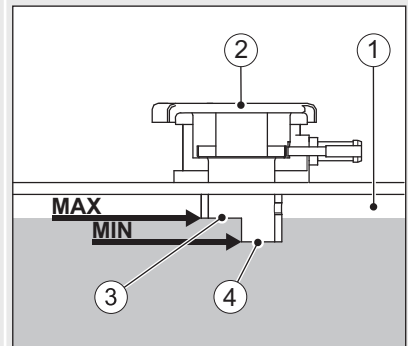

1	Expansion tank for coolant
2	Sealing cap
3	MAX - Maximum coolant level
4	MIN - Minimum coolant level

Procedure for checking the coolant level

Step	Activity
1	The coolant must be between the MIN and MAX marks on a switched-off and cooled-down engine. For a warm engine, the level can also be slightly above the MAX mark.

Procedure for topping up coolant

Step	Activity
1	Carefully open the sealing cap (2).
2	Top up prepared coolant to the MAX mark on the expansion tank. For the preparation of the coolant, see section 4.4 <i>Coolant</i> , page 24.
3	Tighten the sealing cap (2) all the way by hand.

Checking the cooling system for leaks

Coolants losses are mostly caused by leaks in the cooling system.

On a non-leaking cooling system, losses only occur when the coolant boils and this then causes coolant to be pressed out of the cooling system at the sealing cap on the expansion tank. The cause of this can be contamination in the area of the radiator fins (see the chapter 8.2.4 *Checking the radiator fins for dirt accumulation*, page 74).

Overview

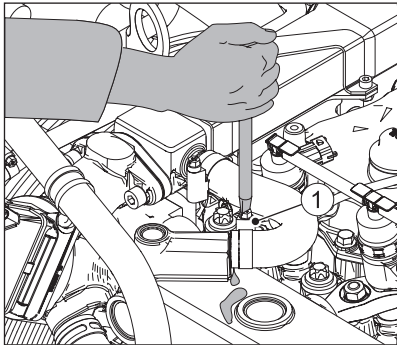

1	Hose clip
---	-----------

Procedure









Step	Activity
1	Check the cooling system for leaks and rectify the cause immediately - in case of doubt consult HATZ Service for advice.
2	When hose connections are loose, retighten the hose clips (1).

8.2.6 Changing the engine oil and oil filter

This chapter contains the following sections:

- **Changing the oil filter**
- **Draining the engine oil**
- **Filling the engine oil**
- **Concluding the inspection work**

Safety notes

 CAUTION	
 	<p>Danger of burns.</p> <p>When working on the engine there is a danger of burns from hot oil.</p> <ul style="list-style-type: none"> ▪ Wear personal protective equipment (gloves).
 CAUTION	
	<p>Danger of environmental damage from spilled used oil.</p> <p>Used oil is water-polluting.</p> <ul style="list-style-type: none"> ▪ Do not allow it to enter the ground water, water bodies, or sewage system. ▪ Collect the used oil and dispose of it according to local environmental regulations.
 CAUTION	
 	<p>Danger of injury</p> <p>Prolonged contact with engine oil can lead to irritation of the skin.</p> <ul style="list-style-type: none"> ▪ Wear safety gloves. ▪ If there is contact with the skin, thoroughly wash the affected areas of the skin with soap and water.
CAUTION	
	<p>Danger of later engine damage.</p> <ul style="list-style-type: none"> ▪ Operating the engine with an oil level below the min. mark or above the max. mark can lead to engine damage. ▪ When checking the oil level, the engine must be horizontal and have been switched off for a few minutes.

NOTICE

- The engine must be level.
- The engine must be switched off.
- Only drain engine oil while it is warm.

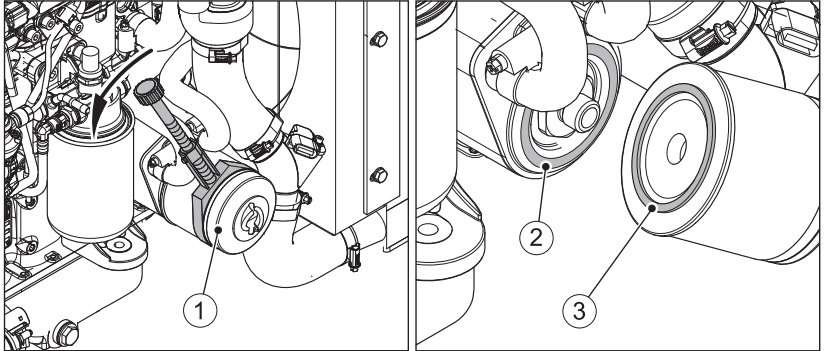
Changing the oil filter**Overview – Horizontal attachment**

1	Oil filter
2	Sealing surface
3	Gasket

Procedure

Step	Activity
1	Keep a container ready for collecting the used oil.
2	Loosen the oil filter (1) with a strap wrench or similar and unscrew it.
3	Dispose of the old filter in accordance with local environmental regulations.
4	Thoroughly clean the sealing surface (2).
5	Lightly oil the sealing lip (3) of the new oil filter.
6	Screw in the oil filter and tighten it by hand .

Overview – Vertical attachment

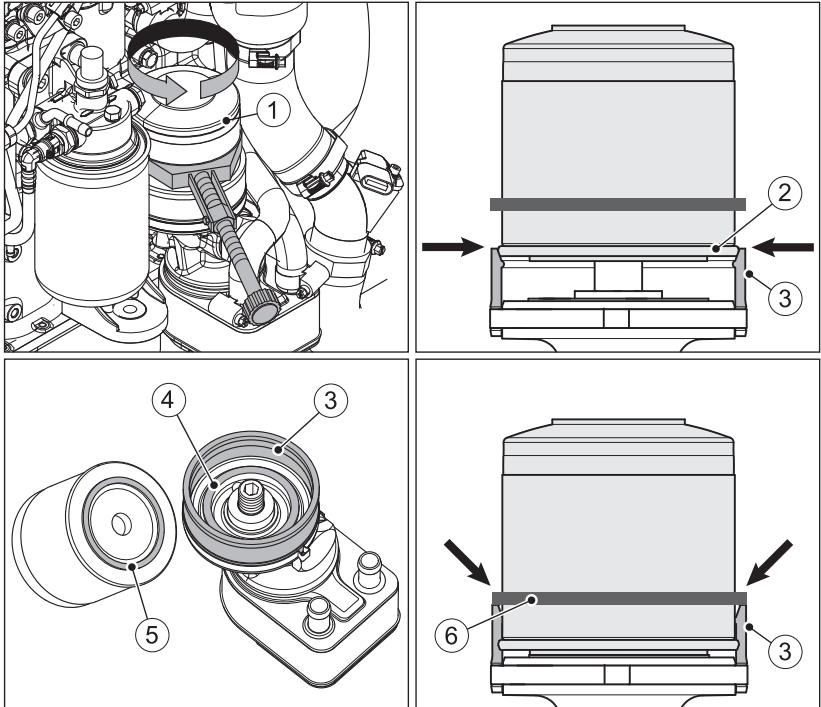

1	Oil filter
2	Collar on the oil filter
3	Shaped element
4	Sealing surface
5	Gasket
6	Guard ring

Procedure

Step	Activity
1	Loosen the oil filter (1) with a strap wrench or similar and unscrew it until the collar (2) of the oil filter is at the same level as the shaped element (3). In this position, a valve releases the oil return into the crankcase which allows the oil filter to empty.
2	Fully unscrew the oil filter after a waiting period of approx. 30 seconds.

Step	Activity
3	Dispose of the old filter in accordance with local environmental regulations.
4	Thoroughly clean the shaped element (3) and sealing surface (4).
5	Lightly oil the sealing lip (5) of the new oil filter.
6	Screw in the oil filter and tighten it by hand .
7	Make sure that the guard ring (6) seats fully on the shaped element (3). The guard ring prevents dirt from accumulating between the oil filter and shaped element.

Draining the engine oil

Overview – Model with oil drain screw

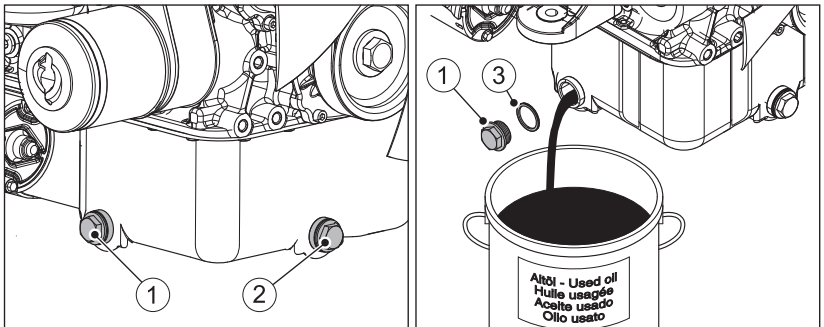

1	Oil drain screw (side)
2	Oil drain screw (front)
3	Gasket

Procedure

Step	Activity
1	Keep a container ready for collecting the used oil. The container must be large enough to hold the entire amount of engine oil. For the engine oil filling quantity, see section 4.1 <i>Engine information and filling quantities</i> , page 21.
2	Depending on accessibility, the engine oil can be drained at oil drain screw (1) or (2). Unscrew the oil drain screw and drain the used oil entirely.
3	Screw in the cleaned oil drain screw with the new gasket (3) and tighten. Tightening torque: 50 Nm.

Overview – Model with oil drain valve

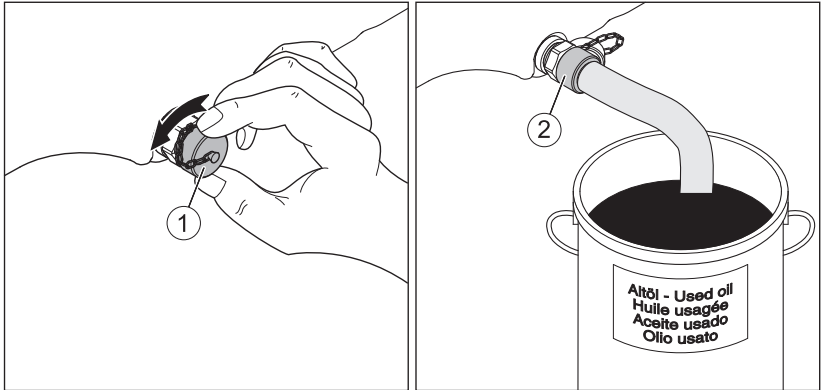

1	Screw plug for oil drain valve
2	Oil drain hose

Procedure

Step	Activity
1	Keep a container ready for collecting the used oil. The container must be large enough to hold the entire amount of engine oil. For the engine oil filling quantity, see section 4.1 <i>Engine information and filling quantities</i> , page 21.
2	Remove the screw plug (1).
3	Place the oil drain hose (2) on the drain valve and tighten by hand. <ul style="list-style-type: none"> ▪ During tightening, the drain valve opens allowing the used oil to drain.
4	Remove the drain hose and reattach the sealing screw.

Filling the engine oil

Overview

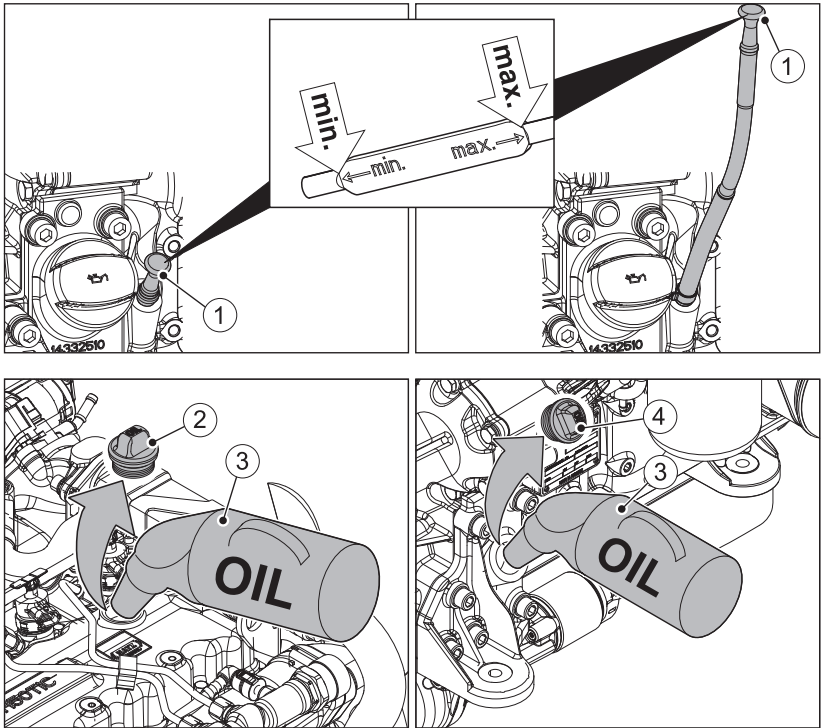

1	Dipstick (depending on the model)
2	Oil filler plug, top
3	Oil refilling container
4	Oil filler plug, bottom

Procedure

Step	Activity
1	Pull out the dipstick (1) and clean it.
2	Depending on accessibility, unscrew oil filler plug (2) or (4).
3	Fill with engine oil. For the specification and viscosity, see section 4.3 <i>Engine oil</i> , page 23. For the filling quantity, see section 4.1 <i>Engine information and filling quantities</i> , page 21.





Step	Activity
4	Reinsert the dipstick.
5	Pull out the dipstick and check the oil level.
6	If required, top up the engine oil to the max. mark.
7	Reinsert the dipstick.
8	Screw in the oil filler plug.

Concluding the inspection work

Step	Activity
1	Check the oil level after a short test run and correct if necessary.
2	Check the oil filter for tightness and retighten by hand if necessary.

8.2.7 Engine cleaning

Safety notes

 DANGER	
	<p>Danger of explosion from flammable cleaning agents.</p> <p>Cleaning with benzene is an explosion hazard. It is highly flammable, can become electrostatically charged, and can generate an explosive gas/air mixture.</p> <ul style="list-style-type: none"> ▪ Use halogen-free, cold cleaners with a high flashpoint for cleaning. ▪ Comply with manufacturer's instructions.
 CAUTION	
	<p>Danger of environmental pollution due to oil and cleaning agents.</p> <p>Oil and cleaning agents are hazardous to the environment.</p> <ul style="list-style-type: none"> ▪ Do not allow them to enter the ground water, water bodies, or sewage system. ▪ Only clean the machine at the washing area intended for this.

**CAUTION****Danger of burns.**

There is a danger of burns when working on a hot engine.

- Let the engine cool.
- Wear safety gloves.

**CAUTION****Danger of injury.**

When working with compressed air, foreign bodies may fly into your eyes.

- Wear safety goggles.
- Never direct the compressed air jet toward people or toward yourself.

**CAUTION****Danger of damage to the machine from incorrect engine cleaning.**

- Let the engine fully cool down before cleaning.
- Do not use gasoline or acid-based cleaning agents.
- The components of the electrical equipment are protected against rain and spray water. Cleaning with a water jet is permitted. When cleaning with a high pressure cleaner, ensure a minimum distance of 100 cm between the high pressure nozzle and engine parts. Otherwise, engine parts can be damaged.
- Never aim the water jet into the intake opening for combustion air or into the exhaust air pipe.

CAUTION**Damage to the radiator fins due to improper cleaning.**

- Never clean the radiator fins with a tool such as a spatula or screwdriver. A reduction in radiator performance through bent radiator fins or radiator leaks may be the result.

NOTICE

In case of heavy contamination, shorten the maintenance intervals accordingly (see chapter 8.2.1 *Maintenance plan, page 66*).

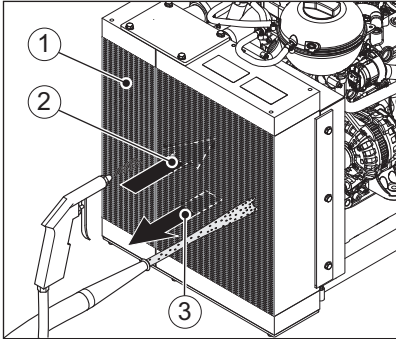
Overview



1	Radiator fins
2	Direction of flow of the cooling air with suction fan
3	Direction of flow of the cooling air with forced-draught fan

Procedure

Step	Activity
Cleaning in case of dry dirt contamination	
1	Depending on the degree of contamination, clean the engine either with compressed air or with a water jet. On the radiator, first work against the direction of flow of the cooling air and then in the direction of flow.
Cleaning wet or oily dirt contamination	
1	Spray the entire area with a suitable cold cleaner according to the manufacturer's instructions and then clean off with a water jet. On the radiator, first work against the direction of flow of the cooling air and then in the direction of flow.
2	Identify the cause of the oiling and seal the leak.
After the cleaning	
1	Let the engine run warm until it has completely dried to prevent rust formation.

8.2.8 Checking the poly v belt

Safety notes

 CAUTION	
	<p>Danger of burns.</p> <p>There is a danger of burns when working on a hot engine.</p> <ul style="list-style-type: none"> ▪ Let the engine cool before maintenance.

Preparation

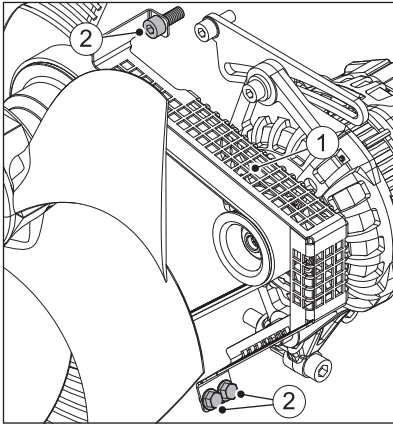

Step	Activity
1	Unscrew the optional belt guard (1). Unscrew the fixing screws (2) for this.

Check the poly v belt for damage.

Overview

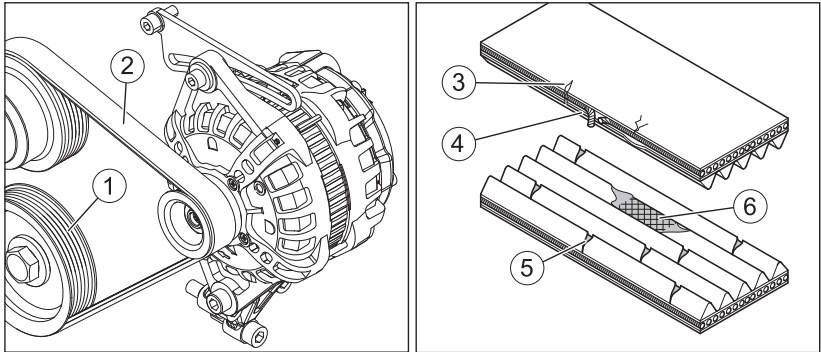

1	Pulley
2	Poly v belt

Damage to the poly v belt

3	Transverse cracks on the rear
4	Fraying on the edges
5	Transverse cracks in multiple ribs
6	Broken ribs

Procedure



Step	Activity
1	<p>Check the poly v belt (2) for the following damage:</p> <ul style="list-style-type: none"> ▪ Transverse cracks on the rear of the belt. ▪ Fraying on the side. ▪ Accumulation of dirt between the ribs. ▪ Oily dirt contamination. ▪ Transverse cracks in multiple ribs. ▪ Broken ribs. <p>If one or more of these instances of damage are present, replace the poly v belt immediately (see section 8.2.10 <i>Replacing the poly v belts</i>, page 92).</p>
2	Mount the belt guard again.

8.2.9 Checking and setting the belt tension

Model without A/C compressor

The following description only applies to engines **without** A/C compressor. For the model **with** A/C compressor, a belt tensioner with spring preload always ensures the correct belt tension. The checking and setting of the belt tension is omitted here. For details, see section 8.2.10 *Replacing the poly v belts*, page 92, subsection *Belt run*.

Safety note

 CAUTION	
	<p>Danger of burns.</p> <p>There is a danger of burns when working on a hot engine.</p> <ul style="list-style-type: none"> Let the engine cool before maintenance.
NOTICE	
	<ul style="list-style-type: none"> The cause of running noises of the poly v belt is mostly that the pretension on the belt is too low. Too low a belt pretension causes early wear of the poly v belt. Regularly check the belt tension, retension the poly v belt if required.

Preparation

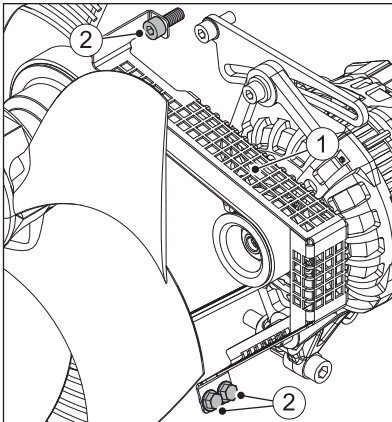

Step	Activity
1	Unscrew the optional belt guard (1). Unscrew the fixing screws (2) for this.

Step	Activity
2	Check the poly v belt for damage (see section 8.2.8 <i>Checking the poly v belt</i> , page 87). Do not retension damaged belts, but replace them immediately (see section 8.2.10 <i>Replacing the poly v belts</i> , page 92).

Overview

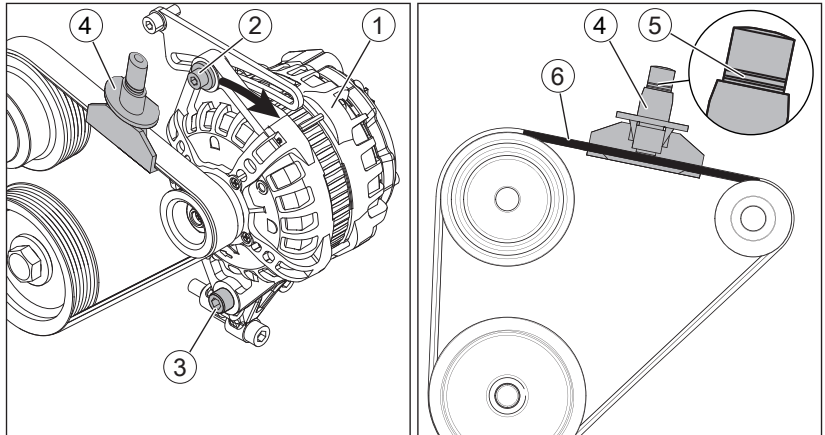

1	Alternator
2	Upper fixing screw on the generator
3	Lower fixing screw on the generator
4	"Facom DM.16" belt tension meter
5	Display on the belt tension meter
6	Measuring point for belt tension

Setting values for the belt tension

The pretensioning force or the vibration frequency of the belt is decisive for adjustment of the belt tension. For this, we recommend the use of the DM.16 belt tension meter from Facom or a frequency meter. If neither of these meters are available, please contact your nearest **HATZ Service**.

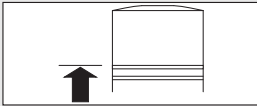
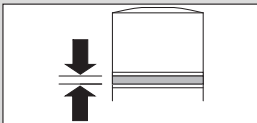
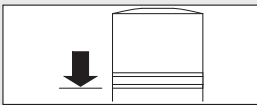
	Belt tension	
	Display (5) on the "Facom" belt tension meter	Vibration frequency (frequency meter)
New belt		210 Hz (+ 10 Hz)
Belt after maintenance interval		150 Hz (+ 10 Hz)
Minimum tension		125 Hz

Procedure



Step	Activity
Checking the belt tension	
1	Check the belt tension at the measuring point (6) in accordance with the manual of the measuring device manufacturer and compare with the <i>setting values for the belt tension</i> . Adjust the belt tension if required.
Setting the belt tension	
1	Undo fixing screws (2) and (3).
2	Turn the generator (1) in the direction of the arrow, hold and - at the same time - tighten the fixing screws of the generator in this position.
3	Check the belt tension again.
4	If necessary, correct the belt tension.

8.2.10 Replacing the poly v belts

This section contains the following subsections:

- **Belt run**
- **Preparatory activities**
- **Engine without A/C compressor**
- **Engine with A/C compressor**

Safety note

	CAUTION
	<p>Danger of burns.</p> <p>There is a danger of burns when working on a hot engine.</p> <ul style="list-style-type: none"> ▪ Let the engine cool before maintenance.

Belt run

Engine without A/C compressor

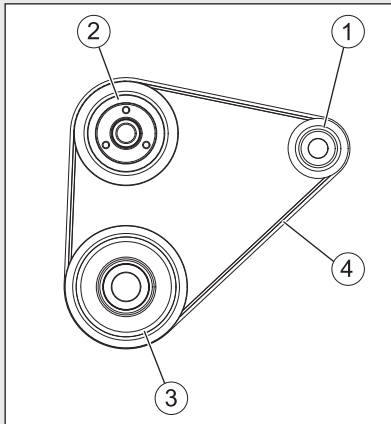

Engine with A/C compressor

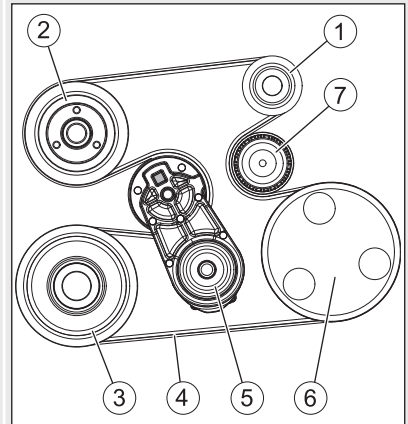

1	Alternator
2	Water pump
3	Crankshaft
4	Poly v belt
5	Belt tensioner
6	A/C compressor
7	Pulley

Preparatory activities

Overview

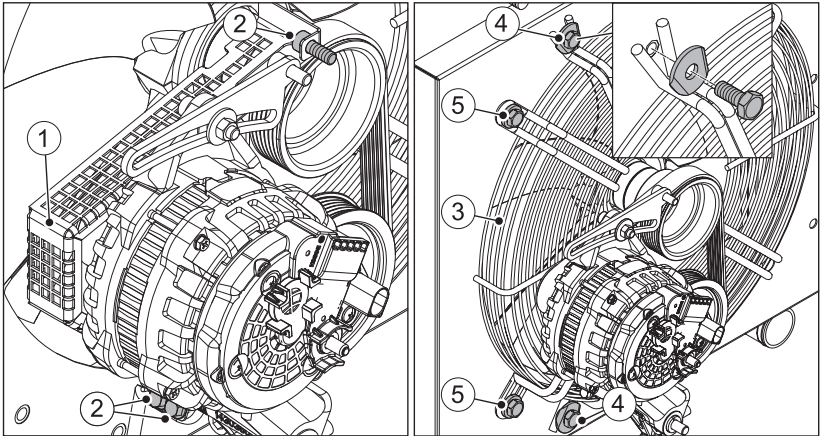

1	Belt guard
2	Fixing screws for the belt guard
3	Protective guard (left half)
4	Connecting screws, protective guard halves (top and bottom)
5	Fixing screws, protective guard (top and bottom)

Procedure

Step	Activity
1	Unscrew the optional belt guard (1). Unscrew the fixing screws (2) for this.
2	Remove the left half of the optional protective guard (3) by unscrewing the screws (4) and (5) (at the top and bottom).

Engine without A/C compressor

Overview

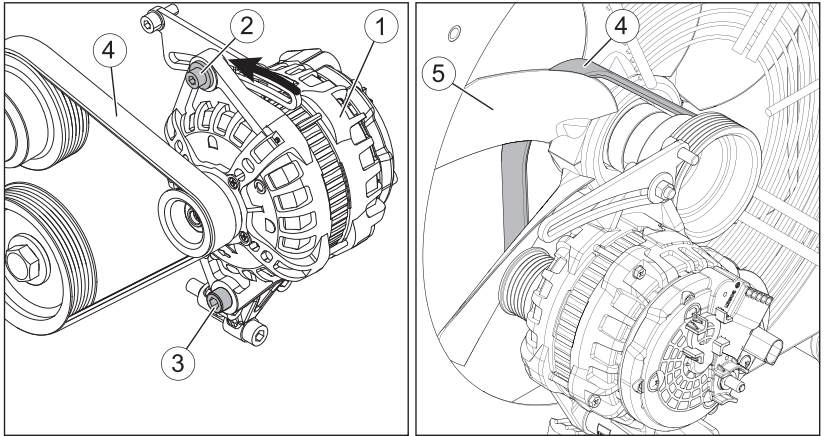



1	Alternator
2	Upper fixing screw on the generator
3	Lower fixing screw on the generator
4	Poly v belt
5	Fan blade

Procedure

Step	Activity
1	Undo fixing screws (2) and (3).
2	Turn the generator (1) in the direction of the arrow to the stop.
3	Remove the loose poly v belt (4) from the pulley.
4	Carefully lift the poly v belt over a fan blade. Turn the fan further in the counterclockwise direction and lift the belt over the remaining fan blades until it is completely free.
5	Check the pulley for perfect condition. If the grooves are broken off or bent, renew the damaged pulley.
6	Feed a new poly v belt over the fan blade in the same way from the radiator side.
7	Lay the poly v belt over the pulleys wheels and tension (see <i>8.2.9 Checking and setting the belt tension, page 89</i>).
8	Mount the protective guard and belt protection again.

Engine with A/C compressor

Safety note

 CAUTION	
	<p>Danger of injury.</p> <p>The belt tensioner is under spring preload. When tensioning and relieving, there is a danger of injury due to crushing or jamming on preloaded parts.</p> <ul style="list-style-type: none"> Carry out the work on the belt with particular caution.

Overview

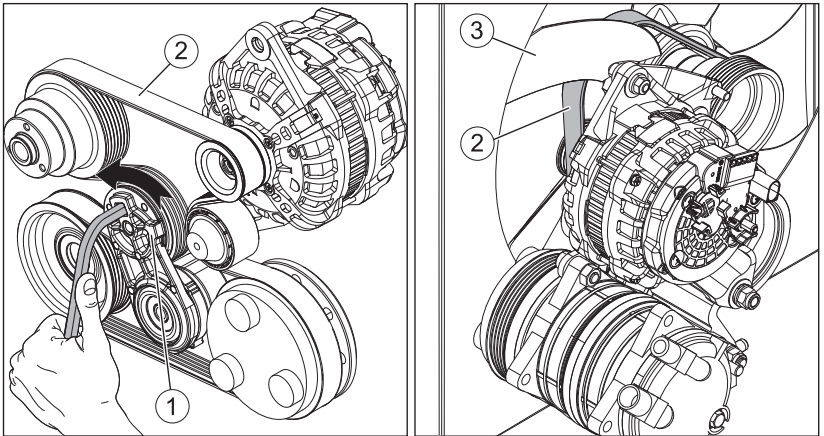

1	Belt tensioner
2	Poly v belt
3	Fan blade



Procedure

Step	Activity
1	Insert a 3/8" square key into the groove in the belt tensioner (1).
2	Turn the belt tensioner in the direction of the arrow, thus relieving the tension of the poly v belt (2).
3	Remove the loose poly v belt from the pulley.
4	Slowly relieve the tension of the belt tensioner.
5	Carefully lift the poly v belt over a fan blade. Turn the fan further in the counterclockwise direction and lift the belt over the remaining fan blades until it is completely free.

Step	Activity
6	Check the pulley, belt tensioner and pulley for perfect condition. If the grooves are broken off or bent, renew the damaged pulley.
7	Feed a new poly v belt over the fan blade in the same way from the radiator side.
8	Place the poly v belts on all pulleys, except the belt tensioners. Monitor the belt run.
9	Turn the belt tensioner in the direction of the arrow and lay on the poly v belt.
10	Slowly relieve the belt tensioner.
11	Check that the poly v belt is correctly placed on the pulley.
12	Reassemble the protective guard and belt protection again.

8.2.11 Changing the oil separator of the crankcase ventilation

Safety note

 CAUTION	
	<p>Danger of burns.</p> <p>There is a danger of burns when working on a hot engine.</p> <ul style="list-style-type: none"> Let the engine cool before maintenance.

Overview

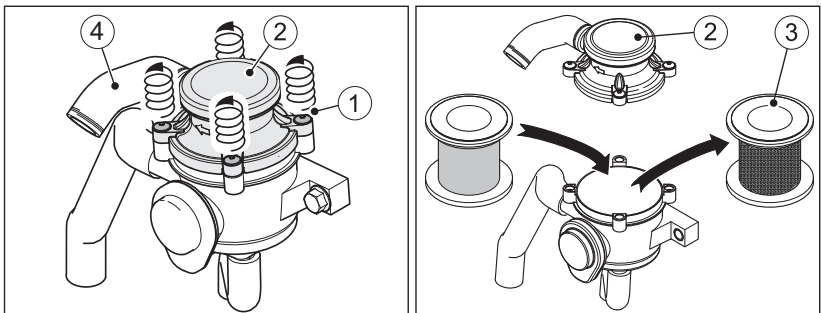

1	Mounting bolts (captive)
2	Breather cap
3	Oil separator cartridge
4	Vent hose

Procedure

Step	Activity
1	Release the four mounting bolts (1) on the breather cap (2).
2	Carefully lift the breather cap. If necessary, release the vent hose (4).
3	Remove the used oil separator cartridge dispose of it according to local environmental regulations.
4	Wipe out the breather housing with a clean cleaning cloth. Make sure that dirt is not brought into the breather housing.
5	Insert a new oil separator cartridge.
6	Put on the breather cap and tighten the four mounting bolts (max. 4 Nm). If necessary, reattach the vent hose.

8.2.12 Checking the screw connections**Safety note****NOTICE**



- Only retighten loose screw connections. Screw connections can be secured with thread locking adhesive or tightened to a defined torque. Retightening tight screw connections can cause damage.
- The adjustment screws on the injection system are secured with locking varnish and are not permitted to be tightened or adjusted.
- Do not retighten the screws for attaching the cylinder head.

Procedure

Step	Activity
1	Check the condition of all screw connections and ensure that they are tight (for exceptions, see note).
2	Tighten any lose screw connections.

8.2.13 Draining the water separator

Safety note

 CAUTION	
	<p>Danger of environmental damage from spilled fuel.</p> <p>When water is drained from the water separator, a small amount of fuel is drained as well.</p> <ul style="list-style-type: none"> Collect any escaped water/fuel mixture and dispose of it according to local environmental regulations.

The fuel prefilter has a water separator. An electronic water level sensor signals when the maximum permissible water level is reached in the water separator. A corresponding flashing code is displayed on the instrument box.

Overview

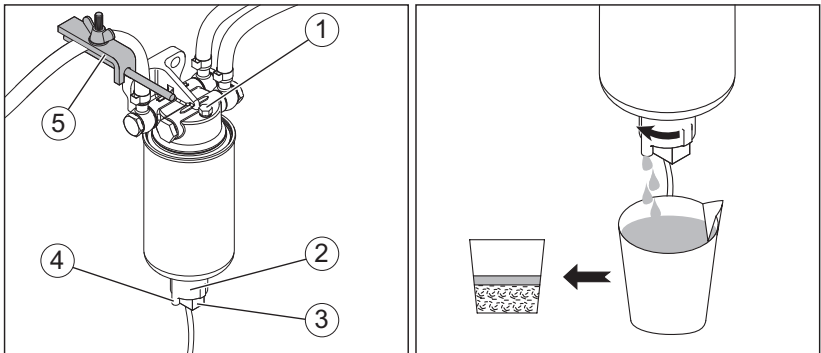

1	Bleed screw
2	Drain plug with integrated water level sensor
3	Water level sensor connector
4	Drain socket for extension hose
5	Hose clip (for a fuel tank positioned low)









Procedure

Step	Activity
1	<p>Place a suitable container under the drain socket (4) of the drain plug (2).</p> <p><i>NOTE:</i> In inaccessible locations, an extension hose can be connected to the drain socket on the drain plug.</p>
2	Open the drain screw (2) and drain the water into the container.

Step	Activity
3	If not enough liquid escapes, undo the additional bleed screw (1). <i>NOTE:</i> If the fuel tank lies lower than the fuel prefilter, the fuel feed line must be clamped off with a hose clip (5). Otherwise fuel will run back into the fuel tank after the drain plug has been unscrewed.
4	As soon as fuel escapes, close the drain plug (2) and bleed screw (1). <i>NOTE:</i> First water escapes then fuel. This can be seen by a clear separating line.
5	Release the fuel feed line if necessary. Dispose of the water/fuel mixture in accordance with the local environmental regulations.

8.2.14 Changing the fuel prefilter

Safety notes

 DANGER	
 	<p>Fire hazard from fuel</p> <p>Leaked or spilled fuel can ignite on hot engine parts and cause serious burn injuries.</p> <ul style="list-style-type: none"> ▪ Do not spill fuel. ▪ No open flames when working on the fuel system. ▪ Do not smoke.
 CAUTION	
	<p>Danger of burns.</p> <p>There is a danger of burns when working on a hot engine.</p> <ul style="list-style-type: none"> ▪ Let the engine cool before maintenance.
 CAUTION	
 	<p>Danger of injury</p> <p>Repeated contact with diesel fuel can cause chapped and cracked skin.</p> <ul style="list-style-type: none"> ▪ Wear safety gloves.

**CAUTION****Danger of environmental damage from spilled fuel.**

When the filter is removed, a small amount of fuel is drained as well.

- Collect any escaping fuel and dispose of it according to local environmental regulations.

CAUTION**Dirt particles can damage the injection system.**

- Maintain clean conditions to ensure dirt does not enter the fuel line.
- Only install fuel filters dry and do not prefill in order to avoid contamination.

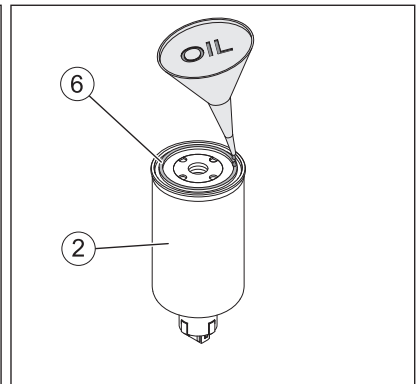
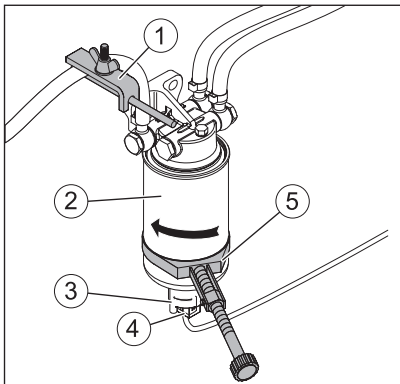
Overview



1	Hose clip on fuel feed line
2	Fuel prefilter
3	Drain plug with integrated water level sensor
4	Water level sensor cable
5	Strap wrench
6	Gasket

Procedure

Step	Activity
1	Lock the fuel supply line on the fuel prefilter.
2	Place a suitable container under the filter to collect emerging fuel.
3	Disconnect the water level sensor cable (4) from the drain plug (3).
4	Release the drain screw (3) and drain the fuel.
5	Unscrew the fuel prefilter. Completely unscrew the drain plug with integrated water level sensor
6	Dispose of the used fuel prefilter according to local environmental regulations.
7	Clean the drain plug with integrated water level sensor and lightly oil the sealing surfaces. Screw the drain plug into the new fuel prefilter.
8	Lightly oil the gasket (6) of the new fuel prefilter, fit the dry filter and tighten it by hand .
9	Release the fuel feed line and connect the cable of the water level sensor.
10	Start the engine and perform a test run. <i>NOTE: When starting the engine, adhere to the procedure in "6.6 Starting the engine for the first time or after a fuel filter replacement, page 52".</i>
11	After the test run, check the fuel prefilter and drain plug for leaks, tighten by hand if necessary.

8.2.15 Changing the main fuel filter

Safety notes

 DANGER	
 	<p>Fire hazard from fuel</p> <p>Leaked or spilled fuel can ignite on hot engine parts and cause serious burn injuries.</p> <ul style="list-style-type: none"> ▪ Do not spill fuel. ▪ No open flames when working on the fuel system. ▪ Do not smoke.

**WARNING****Danger of injury due to fuel splashes.**

Fuel can exit under pressure when the main fuel filter is removed.



- Carefully remove the main fuel filter.
- Wear safety goggles.

**CAUTION****Danger of burns.**

There is a danger of burns when working on a hot engine.

- Let the engine cool before maintenance.

**CAUTION****Danger of injury**

Repeated contact with diesel fuel can cause chapped and cracked skin.



- Wear safety gloves.

**CAUTION****Danger of environmental damage from spilled fuel.**

When the filter is removed, a small amount of fuel is drained as well.

- Collect any escaping fuel and dispose of it according to local environmental regulations.

CAUTION**Dirt particles can damage the injection system.**

- Maintain clean conditions to ensure dirt does not enter the fuel line.
- Only install fuel filters dry and do not prefill in order to avoid contamination.

Overview

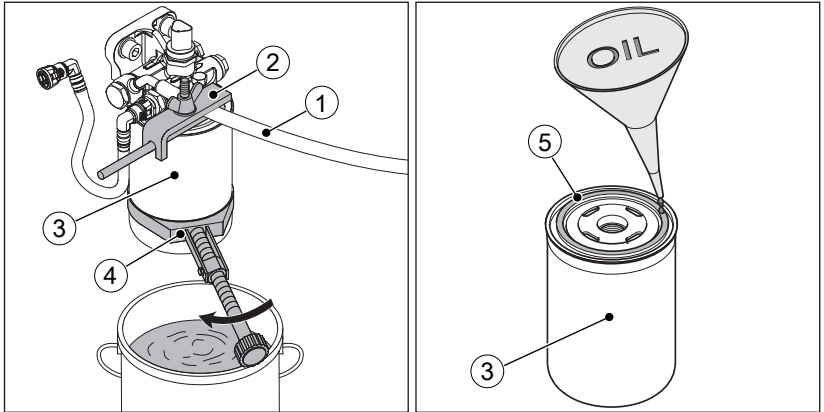





1	Fuel feed line
2	Hose clip
3	Main fuel filter
4	Strap wrench
5	Gasket

Procedure

Step	Activity
1	Block the fuel feed line (1) using the hose clip (2).
2	Place a suitable container under the filter to collect emerging fuel.
3	Unscrew the main fuel filter (3) and dispose of it according to local environmental regulations.
4	Lightly oil the gasket (5) of the new main fuel filter.
5	Fit the filter and tighten it by hand .
6	Release the fuel feed line.
7	Start the engine and perform a test run. <i>NOTE: When starting the engine, adhere to the procedure in "6.6 Starting the engine for the first time or after a fuel filter replacement, page 52".</i>
8	After the test run, check the main fuel filter for leaks and tighten by hand if necessary.

8.2.16 Servicing the air filter (optional)

Safety notes

 CAUTION	
 	<p>Danger of injury.</p> <p>When working with compressed air, foreign bodies may fly into your eyes.</p> <ul style="list-style-type: none"> ▪ Wear safety goggles. ▪ Never direct the compressed air jet toward people or toward yourself.
NOTICE	
	<ul style="list-style-type: none"> ▪ Change the filter elements when there is oily or damp dirt contamination, cleaning is not possible. ▪ Even minor damage in the areas of the sealing surface, filter paper, or filter cartridge makes reuse impossible. ▪ The filter cartridge may not be washed out or beaten out. ▪ The filter cartridge may be blown out only in exceptional cases. The pressure must not exceed 5 bar.

Overview

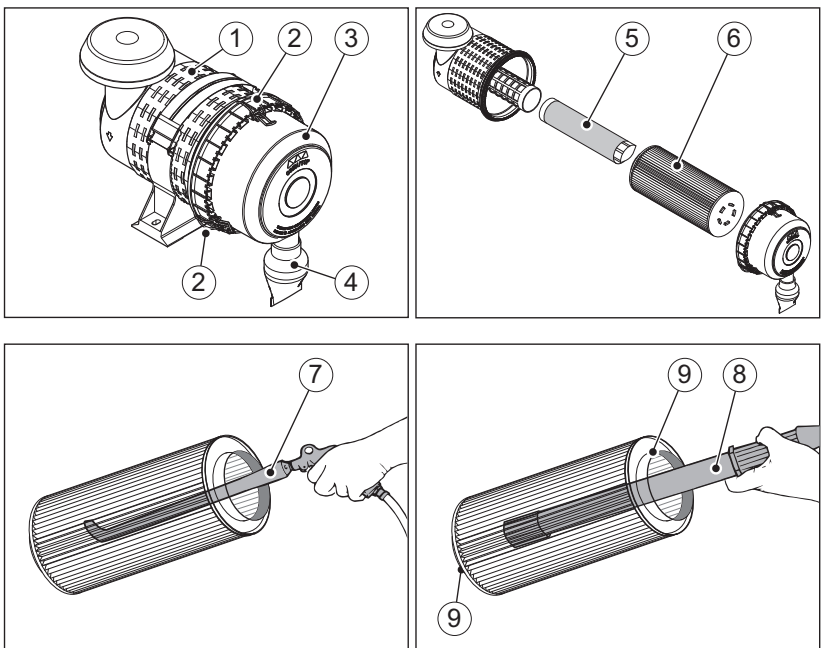

1	Air filter housing
2	Retaining clips
3	Air filter cover
4	Dust discharge valve
5	Secondary filter
6	Primary filter
7	Air gun with extension tube (tip bent)
8	Lamp
9	Sealing surfaces

Replacing the primary/secondary filters

Step	Activity
1	Open the retaining clips (2) and remove the air filter cover (3).
2	Pull out the primary filter (6) and either replace (recommended) or clean (see below). Replace or clean the primary filter according to the service interval indicator. The primary filter must be replaced every two years at the latest however, cleaning is no longer possible after this time.
3	Remove dirt adhering to the inside of the air filter housing (1), air filter cover (3), and dust discharge valve (4).
4	Pull out and check the secondary filter (5), replace if required. The secondary filter can not be cleaned. The secondary filter must be replaced after every fifth replacement of the primary filter, though no later than every two years.
5	Carefully insert new filter elements.
6	Place the air filter cover on the air filter housing and lock all retaining clips making sure that the dust discharge valve points vertically downwards.

Cleaning the primary filter

Step	Activity
1	Blow out the primary filter (6) with dry compressed air from the inside to the outside until dust no longer emerges. Use an air gun with an extension tube (7) with the end bent by approx. 90°. The end of the extension tube must not touch the filter paper.
2	Check the sealing surfaces (9) of the filter cartridge for damage.







Step	Activity
3	<p>Check the filter cartridge for tears or other damage in the filter paper by holding it against the light at a slant or shining light from a lamp (8) through it. In case of doubt, always replace the primary filter.</p> <p><i>NOTE:</i> The primary filter may only be cleaned once, then it must be replaced.</p>

8.2.17 Changing coolant

This section contains the following subsections:

- **Draining the cooling system**
- **Rinsing the cooling system**
- **Filling the cooling system**

Safety notes

 CAUTION	
 	<p>Danger of scalding and risk of environmental damage due to hot coolant.</p> <ul style="list-style-type: none"> ▪ Excessive coolant is blown off from the sealing cap on the expansion tank. After topping up the cooling system never move parts of your body or face close to the sealing cap. ▪ Never top up coolant above the MAX - mark on the expansion tank. ▪ Never stop escaping coolant with your bare hands.
 CAUTION	
 	<p>Danger of burns.</p> <p>There is a danger of burns when working on a hot cooling system. The cooling system is pressurized when the engine is hot.</p> <ul style="list-style-type: none"> ▪ Let the engine cool. ▪ Wear safety gloves.



CAUTION



Danger of environmental damage from spilled coolant.

Coolant is water-polluting.

- Do not allow it to enter the ground water, water bodies, or sewage system.
- Collect the coolant and dispose of it according to local environmental regulations.

Overview

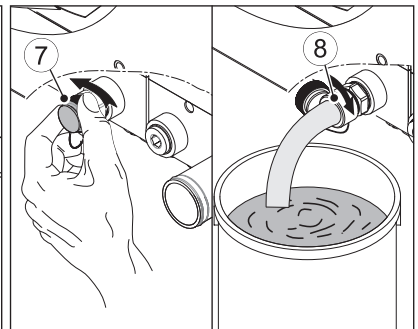
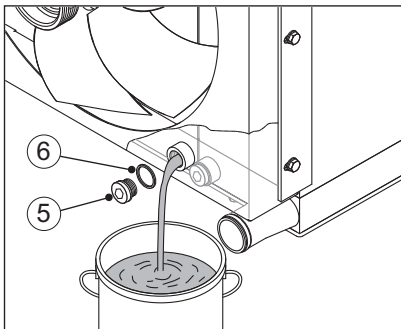
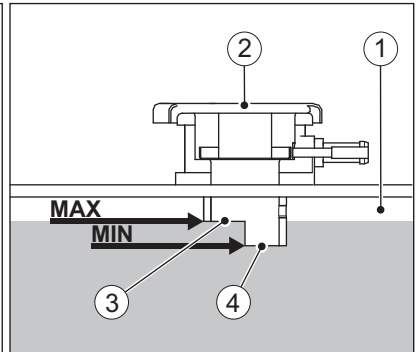
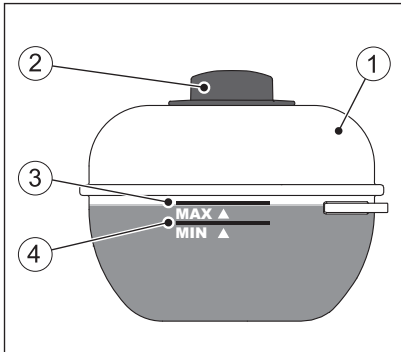

1	Expansion tank for coolant
2	Sealing cap
3	MAX - Maximum coolant level
4	MIN - Minimum coolant level
5	Drain plug on the radiator
6	Seal ring
7	Screw plug for drain valve

8	Drain hose
---	------------

Draining the cooling system

Step	Activity
1	Provide a container to collect the used coolant. The container must be large enough to hold the entire amount of oil. For the amount of coolant, see section 4.1 <i>Engine information and filling quantities</i> , page 21.
2	Open the sealing cap (2) of the expansion tank (1).

Model with drain plug

3	Unscrew the drain plug (5) and drain the coolant into the container.
4	Screw in the drain plug (5) with a new gasket (6) and tighten. Tightening torque: 50 Nm.

Model with drain valve

3	Remove the screw plug (7). Then place the drain hose (8) on the drain valve and screw tight by hand. <ul style="list-style-type: none"> ▪ When tightening, the drain valve opens allowing the coolant to drain.
4	Remove the drain hose and reattach the sealing screw.

Rinsing the cooling system

The cooling system only needs to be rinsed if contaminants are detected in the coolant.

Contaminants can include:

- Engine oil due to a defective cylinder head gasket (discoloration of the coolant).
- Corrosion due to used or unsuitable coolant (discoloration of the coolant).
- Foreign bodies due to:
 - Insufficient cleaning during repairs to the cooling system
 - Reuse of drained coolant

As contaminants in the coolant could be an indication of a larger problem, we recommend having the rinsing of the cooling system carried out by trained specialist personnel.

Filling the cooling system

See section 6.5 *Filling the cooling system*, page 50

8.2.18 Resetting the maintenance interval indicator

After completion of maintenance work reset the maintenance interval indicator. The counter starts again at zero and indicates when the next larger service is due.

Overview – HATZ instrument boxes

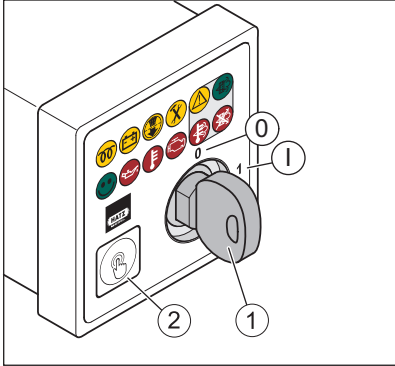

1	Starting key
2	Pushbutton
Ignition lock	
0	Off
I	Operation

Procedure

Step	Activity
1	The starting key is at position "0". <ul style="list-style-type: none"> Press and hold down the button (2).
2	Turn the starting key from position "0" to position "I".
3	Release the button (2) after a wait time of at least 5 seconds but no longer than 10 seconds. The maintenance interval indicator is now reset.

NOTICE



If a HATZ instrument box is not used:

Comply with the instructions in the documentation for the **complete machine**.

9 Faults

9.1 Troubleshooting

General troubleshooting notes

If the cases listed below have been worked through but the fault continues to persist, please contact your nearest **Hatz service station**.

Indicator for engine fault on the HATZ instrument box is flashing.

Possible causes	Remedy	Chapter
Various errors in different assemblies.	Use the flash code table to identify and eliminate errors.	<i>9.2 Flash code table for engine faults, page 113</i>

The engine does not start or does not start immediately, but can be turned with the starter.

Possible causes	Remedy	Chapter
Hydraulic load too high (especially with multiple hydraulic pumps).	Reduce the hydraulic load – if possible.	
Insufficient compression.	Contact HATZ Service.	
Cylinder and/or piston ring wear.	Contact HATZ Service.	
Fuel supply is interrupted:		
The tank ran out of fuel during operation.	Add fuel.	<i>7.6 Refueling, page 64</i>
Electrical fuel pump is not working.	Check the cabling.	
Fuel prefilter is clogged.	Change the fuel prefilter.	<i>8.2.14 Changing the fuel prefilter, page 99</i>
Main fuel filter is clogged.	Change the main fuel filter.	<i>8.2.15 Changing the main fuel filter, page 101</i>

At low temperatures (engine does not start)

Possible causes	Remedy	Chapter
Oil is too viscous and causes a too low starter speed.	Change the engine oil and oil filter. Add engine oil with a suitable viscosity class.	8.2.6 <i>Changing the engine oil and oil filter, page 78</i>
Insufficiently charged battery.	Check the battery and contact the service center if necessary.	3.2.4 <i>Electrical equipment, page 18</i>
Machine is not uncoupled.	If possible, separate the engine from the machine by uncoupling it.	

The starter does not switch on and the engine does not turn.

Possible causes	Remedy	Chapter
Irregularities in the electrical equipment:		
Battery and/or other cable connections are incorrectly connected.	Check the electrical equipment and its components or contact Hatz service.	3.2.4 <i>Electrical equipment, page 18</i>
Cable connections are loose and/or oxidized.		
Battery is faulty and/or not loaded.		
Faulty starter.		
Faulty relay, monitoring elements, etc.		

Engine switches off spontaneously during operation.

Possible causes	Remedy	Chapter
The tank ran out of fuel during operation.	Fill with fuel.	7.6 <i>Refueling, page 64</i>
Mechanical faults.	Contact HATZ Service.	
Electrical defects.	Check wiring or contact HATZ Service.	

The engine loses power and speed.

Possible causes	Remedy	Chapter
Engine running due to a fault in the emergency run function (instrument box sends flashing signal).	Heed the flashing code table.	9.2 <i>Flash code table for engine faults, page 113</i>
	Switch off the engine, wait at least 1 minute, then restart the engine. (This deletes minor errors).	7.4 <i>Switching off the engine, page 60</i> 7.3 <i>Starting the engine, page 58</i>
The tank ran out of fuel during operation.	Add fuel.	7.6 <i>Refueling, page 64</i>

The engine loses power and speed, and black smoke emerges from the exhaust.

Possible causes	Remedy	Chapter
Dirty air filter unit.	Check the degree of dirt contamination of the air filter, and clean or renew it if necessary.	8.2.16 <i>Servicing the air filter (optional), page 104</i>
Turbocharger faulty or leaking hoses.	Check hoses or contact HATZ Service.	
Injector not fully functional.	Contact HATZ Service.	

Engine becomes very hot. The engine temperature indicator lights up.

Possible causes	Remedy	Chapter
Contamination in the entire area of the cooling air guides.	Clean the cooling air area.	
Radiator fins dirty, or radiator blocked.	Clean the radiator fins, ensure air flow through radiator is not hindered.	8.2.7 <i>Engine cleaning, page 84</i> 8.2.5 <i>Checking the cooling system, page 75</i>
Thermostat or water pump faulty.	Contact HATZ Service.	
Coolant level too low.	Check the cooling system.	8.2.5 <i>Checking the cooling system, page 75</i>

9.2 Flash code table for engine faults

When engine faults occur, a flashing signal is shown on the indicator lamp for "Engine fault" (see *Explanation of symbols*, chapter 5.2 HATZ instrument box, page 40). The table below shows the possible flashing signals, their meaning and measures for remedies.

If the listed fault cases have been worked through but the fault continues to persist, please contact your nearest **HATZ Service**.

The following graphic shows the setup of the flashing code of the flashing signal **2 – 2**:

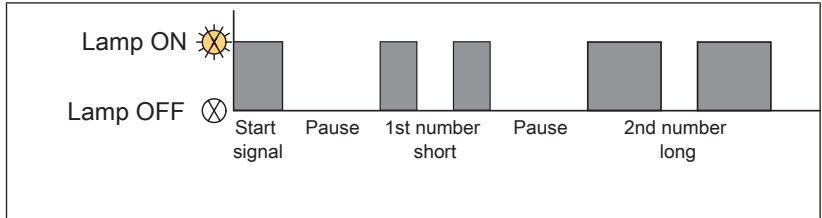

If there are two or more faults, they can be displayed by pressing on the pushbutton again.

Flash code table





Flashing signal	Possible causes	Remedy	Chapter
1 – 1 <i>Area affected:</i> Monitoring of indicator and control elements	Indicator(s) or cabling faulty.	Check the function and cabling of the indicators.	
	Insufficient control unit power supply.	Check the power supply of the control unit.	
	Other errors not specified in more detail.		
1 – 2 <i>Area affected:</i> Speed sensor system	Crankshaft or camshaft sensor cabling faulty.	Check the cabling.	

Flashing signal	Possible causes	Remedy	Chapter
1 – 3 <i>Area affected:</i> Air supply	Air filter is dirty.	Service the air filter.	8.2.16 <i>Servicing the air filter (optional), page 104</i>
	Charge air temperature after the charge air cooler too high.	Clean the radiator fins.	8.2.7 <i>Engine cleaning, page 84</i>
	Charge air sensor/air filter differential pressure sensor cabling faulty.	Check the cabling.	
1 – 4 <i>Area affected:</i> Exhaust gas recirculation (EGR)	Cabling for EGR valve defective.	Check the cabling.	
2 – 1 <i>Area affected:</i> Low pressure fuel system	Maximum water level in the water separator reached.	Drain water from the fuel prefilter.	8.2.13 <i>Draining the water separator, page 98</i>
	Fuel pressure too low.	<ul style="list-style-type: none"> ▪ Replace both fuel filters. ▪ Check the fuel tank level, refuel if required. 	7.6 <i>Refueling, page 64</i>
	Fuel temperature too high. This can be caused by a low level in the fuel tank or a high engine load.	<ul style="list-style-type: none"> ▪ Refuel. ▪ Reduce the engine load. 	
	Cabling of the fuel pump defective.	Check the cabling.	
2 – 2 <i>Area affected:</i> High pressure fuel system	Sensor system (injectors, rail pressure sensor, pressure control valve, high pressure pump) cabling faulty.	Check the cabling.	

Flashing signal	Possible causes	Remedy	Chapter
2 – 3 <i>Area affected:</i> Engine oil temperature/engine oil pressure	Engine oil pressure too high/too low.	<ul style="list-style-type: none"> ▪ Check the oil level, top up the engine oil if required. ▪ Use engine oil with a suitable viscosity. 	<i>7.5 Check the oil level, page 62</i> <i>4.3 Engine oil, page 23</i>
	Engine oil temperature too high.	Check the hoses of the oil cooler (hose kinked).	
	Cabling of the sensor defective.	Check the cabling.	
3 – 1 <i>Area affected:</i> Liquid cooling	Coolant level too low.	Top up coolant.	<i>8.2.5 Checking the cooling system, page 75</i>
	Coolant temperature too high.	Clean the radiator fins.	<i>8.2.7 Engine cleaning, page 84</i>
	Coolant temperature sensor cabling faulty.	Check the cabling.	
	Coolant level sensor cabling defective.	Check the cabling.	
3 – 2 <i>Area affected:</i> Pre-glow system	Glow plugs cabling faulty.	Check the cabling.	
	One or multiple glow plugs faulty.	Contact HATZ Service.	
	Glow control unit (GCU) faulty.	Contact HATZ Service.	

9.3 Start support

Safety notes

 DANGER	
	<p>Danger of explosion due to the generation of sparks.</p> <p>When carrying out the start support, a battery can generate an explosive gas mixture.</p> <ul style="list-style-type: none">▪ Avoid fire, sparks, open flames and smoking.▪ Avoid short-circuits.▪ Only connect battery terminals with identical polarity (see <i>Overview</i> section).▪ Always observe the sequence described for connecting and disconnecting the start support cable.▪ Do not place tools or other metal objects on the battery.
 WARNING	
  	<p>Danger of chemical burns.</p> <p>Battery acid is highly corrosive and can cause eye and skin injuries.</p> <ul style="list-style-type: none">▪ Wear safety goggles and safety gloves.



WARNING

Danger of injury or property damage due to incorrectly carried out start support.

If the instructions for the start support are not adhered to precisely, there is a danger of explosion due to the generation of sparks as well as a danger of chemical burns due to leaking battery acid.

- Observe the attached information and warning signs (see section 3.3 *Labels*, page 19)
- Do not use a charger unit with Boost function. Electrical components could be destroyed due to overvoltage.
- Use a suitable start support cable with insulated cable pliers.

Required line cross-section:

- 12 volts min. 50 mm²
- 24 volts min. 35 mm²
- Never swap the positive (+) and negative (-) battery terminals (danger of short circuit).
- Make sure that the start support cables are laid in such a way that they cannot be damaged by rotating parts or become disconnected from the battery terminals.
- A discharged battery and current emitting battery must have the same voltage (12 volts). The battery capacity should be about the same.
- A discharged battery can freeze even at temperatures just a few degrees below zero. If the battery is frozen or thawed, do not carry out a start support. Replace the battery.



Overview – 12 volt model

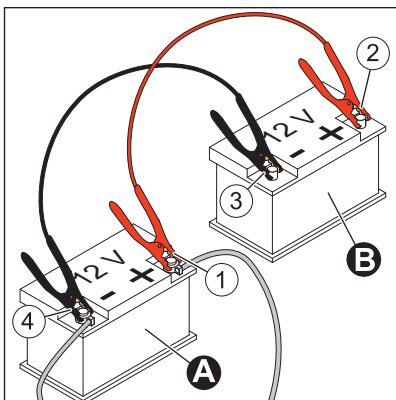

Battery	
A	Discharged battery
B	Current emitting battery
Red start support cable (positive (+) terminal)	
1	Clamp pliers on the positive (+) terminal of the discharged battery
2	Clamp pliers on the positive (+) terminal of the current emitting battery
Black start support cable (negative (-) terminal)	
3	Clamp pliers on the negative (-) terminal of the current emitting battery
4	Clamp pliers on the negative (-) terminal of the discharged battery

Procedure – 12 volt model

Step	Activity
1	A second battery (12 volts) or an external device with a 12 volt system can be used for the start support. See also the instructions in the documentation for the external device.
2	Turn the starting key to position "0" on both machines.
3	Connect the batteries using the clamp pliers of the start support cable in the sequence 1–2–3–4 (see <i>Overview – 12 volt model</i>).
4	Do not start the external device.
5	Start the machine with the discharged battery.
6	Let the engine run for several minutes.
7	Disconnect the start support cable in the sequence 4–3–2–1.

Overview – 24 volt model

NOTICE

The 24 volt model is supplied with two 12 volt batteries that are connected in series with a connection cable (C).

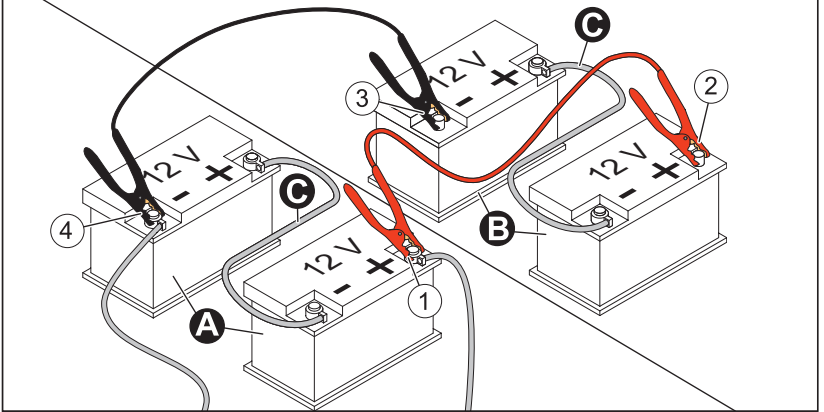
**Batterys**

A	Discharged batteries
B	Current emitting batteries
C	Connection cable between the batteries

Red start support cable (positive (+) terminal)

1	Clamp pliers on the positive (+) terminal of the discharged battery
2	Clamp pliers on the positive (+) terminal of the current emitting battery

Black start support cable (negative (-) terminal)

3	Clamp pliers on the negative (-) terminal of the current emitting battery
4	Clamp pliers on the negative (-) terminal of the discharged battery











Procedure – 24 volt model

Step	Activity
1	Either two batteries (12 volts) with connection cable (C) can be used for start support in accordance with <i>Overview – 24 volt model</i> or an external device with a 24 volt system. See also the instructions in the documentation for the external device.
2	Turn the starting key to position "0" on both machines.
3	Connect the batteries using the clamp pliers of the start support cable in the sequence 1–2–3–4 (see <i>Overview – 24 volt model</i>).
4	Do not start the external device.
5	Start the machine with the discharged battery.
6	Let the engine run for several minutes.
7	Disconnect the start support cable in the sequence 4–3–2–1.

10 Storage and disposal

10.1 Storing the machine

Safety notes

 DANGER	
	<p>Danger to life from inhaling exhaust gases.</p> <p>Toxic engine exhaust gases can lead to loss of consciousness and even death in closed-off and poorly ventilated rooms.</p> <ul style="list-style-type: none"> ▪ Never operate the machine in closed-off or poorly ventilated rooms. ▪ Do not breathe in the exhaust gases.
 DANGER	
 	<p>Fire hazard from fuel.</p> <p>Leaked or spilled fuel can ignite on hot engine parts and cause serious burn injuries.</p> <ul style="list-style-type: none"> ▪ Only refuel when the engine is switched off. ▪ Never refuel in the vicinity of open flames or sparks that can cause ignition. ▪ Do not smoke. ▪ Do not spill fuel.
 CAUTION	
	<p>Danger of environmental damage from spilled fuel.</p> <p>Do not overfill the fuel tank and do not spill fuel.</p> <ul style="list-style-type: none"> ▪ Collect any leaking fuel and dispose of it according to local environmental regulations.
 CAUTION	
 	<p>Danger of burns.</p> <p>There is a danger of burns when working on a hot cooling system. The cooling system is pressurized when the engine is hot.</p> <ul style="list-style-type: none"> ▪ Let the engine cool. ▪ Wear safety gloves.

NOTICE**Comply with the safety chapter!**

Follow the basic safety instructions in chapter 3 *Safety*, page 7.

Storing the machine for a lengthy period

Take the following measures if you intend to take the machine out of service for a lengthy period (3-12 months):

Step	Activity
1	Drain the fuel tank until it is nearly empty and fill with FAME*-free fuel. Operate the engine for a few minutes so that only FAME-free fuel is still in the fuel system.
2	Change the engine oil and oil filter (see section 8.2.6 <i>Changing the engine oil and oil filter</i> , page 78).
3	Replace the fuel prefilter and the main fuel filter (see section 8.2.14 <i>Changing the fuel prefilter</i> , page 99 and 8.2.15 <i>Changing the main fuel filter</i> , page 101).
4	Let the machine cool down.
5	Check the coolant level and concentration. Refill coolant if necessary (see section 8.2.5 <i>Checking the cooling system</i> , page 75). If the concentration is too low, replace the coolant (see section 8.2.17 <i>Changing coolant</i> , page 106).
6	Remove the battery in accordance with the Operator's Manual for the machine and store at ambient temperature. Comply with the local regulations as well as the regulations of the battery manufacturer for the storage of batteries.
7	Close and seal all engine openings (air intake openings, air outlet openings and the exhaust gas opening) so that no foreign bodies can enter, but a small amount of air can still be exchanged. This avoids condensation.
8	After the machine has cooled down, cover it to protect it against dust and store it in a dry and clean place.

*FAME = Fatty Acid Methyl Ester

Ambient conditions during storage

- Max. permissible storage temperature: -25 °C to +60 °C
- Max. permissible humidity: 70%
- Protect the engine from direct sunlight

Recommissioning

Step	Activity
1	Remove all covers.
2	Check the cables, hoses and lines for cracks and leak tightness.
3	Check the engine oil level.
4	Check the coolant level.
5	Install the battery in accordance with the Operator's Manual for the machine.

The brand new engine can normally be stored for up to 12 months. The protection lasts up to approx. 6 months at very high humidity and in sea air.

For storage periods of more than 12 months, please contact the nearest **HATZ Service**.

10.2 Disposing of the machine

Disposal information

Dispose of the machine (including machine parts, engine oil, coolant, and fuel) according to the local disposal regulations and the environmental laws in the country of use.

Because of the danger of possible environmental damage, only permit an approved specialist company to dispose of the machine.

NOTICE



When the machine has reached the end of its lifecycle, ensure that it is disposed of safely and properly, especially parts and substances that can be dangerous to the environment. These also include fuel, coolant, lubricants, plastics, and batteries (if present).

- Do not dispose of the battery with the household trash.
- Dispose of the battery at a collection point for possible recycling.

11 Installation declaration

Extended Declaration of Incorporation EC Machinery Directive 2006/42/EC

The manufacturer: **Motorenfabrik Hatz GmbH & Co.KG**
Ernst-Hatz-Straße 16
D-94099 Ruhstorf a. d. Rott

hereby declares that the incomplete machine: product description: **Hatz diesel engine**

Type designation and as of serial number:

3H50TIC = 13510, 3H50TI = 16310

4H50TIC = 13610, 4H50TI = 16110

satisfies the following basic safety and health protection requirements in acc. with Annex I to the above-mentioned Directive.

- Annex I, General principles no. 1
- Nr. 1.1.2., 1.1.3., 1.1.5., 1.2.1., 1.2.2., 1.2.3., 1.2.4.1., 1.2.4.2., 1.3.1., 1.3.2., 1.3.3., 1.3.4., 1.3.7., 1.3.8.1., 1.4.1., 1.5.1., 1.5.2., 1.5.8., 1.5.9., 1.6.1., 1.6.2., 1.6.4., 1.7.

All relevant basic safety and health protection requirements down to the interfaces described

- in the manual for diesel engine
- in the enclosed data sheets
- in the enclosed technical documents

have been complied with.

The special technical documents in acc. with Annex VII B of the Directive 2006/42/EC have been prepared.

Conformity with the provisions of the following, other EC Directives, i.e.

- **2014/30/EU Electromagnetic Compatibility (EMC)**, dated 26.02.2014
(was tested in association with a generator)

The following standards have been used (completely or partially):

- EN 1679-1: 092011
- EN ISO 12100: 032011
- EN ISO 13857: 062008
- EN 60204-1: 062007
- EN ISO 13849-1: 062016

The manual for diesel engine has been enclosed to the incomplete machine and the Assembly Instructions have been provided to the customer electronically together with the order confirmation.

Commissioning has been prohibited until it has been established, if applicable, that the machine into which the above-mentioned incomplete machine is to be incorporated, satisfies the provisions of the Machinery Directive.

Wolfgang Krautloher / see "Manufacturer"
 Name / address of EC documentation officer

03.07.2017

Krautloher / Directives official

Date

Signature and information on the undersigned



Signature

12 EPA AND CARB CERTIFIED ENGINES

**SUPPLEMENTAL INFORMATION
TO THE OWNER'S MANUAL FOR MODEL YEAR 2018
FOR EPA AND CALIFORNIA CERTIFIED NONROAD
COMPRESSION IGNITION ENGINES.**

**EPA AND CALIFORNIA EMISSION CONTROL
SUPPLEMENTAL WARRANTY STATEMENT.**

EPA AND CARB EMISSION CONTROL WARRANTY STATEMENT.

YOUR WARRANTY RIGHTS AND OBLIGATIONS.

The California Air Resources Board and Motorenfabrik Hatz GmbH & Co. KG is pleased to explain the emission control system warranty on your Model Year 2018 engine. In California, new heavy-duty off-road engines must be designed, built, and equipped to meet the State's stringent anti-smog standards. The Motorenfabrik Hatz GmbH & Co. KG must warrant the emission control system on your engine for the periods of time listed below provided there has been no abuse, neglect or improper maintenance of your engine.

Where a warrantable condition exists, the Motorenfabrik Hatz GmbH & Co. KG will repair your heavy-duty off-road engine at no cost to you including diagnosis, parts, and labor.

MANUFACTURER'S WARRANTY COVERAGE.

The Model Year 2018 heavy-duty off-road engines are warranted for the periods described below. Motorenfabrik Hatz GmbH & Co. KG warrants to the original owner, and to each subsequent owner, of a new, diesel engine that the emission control system of your engine:

- Was designed, built and equipped so as to conform at the time of sale with all applicable regulations of the California Air Resources Board (CARB).
- Is free from defects in material and workmanship that will cause such engine to fail to conform with applicable regulations for the following warranty period:

If your engine is certified as . . .	And its maximum power is . . .	And its rated speed is . . .	Then its warranty period is . . .
Variable speed or constant speed	kW <19 (25 HP)	Any speed	1.500 hours or two years, whichever comes first.
Constant speed	19 ≤ kW <37 (25 ≥ HP <50)	3.000 rpm or higher	1.500 hours or two years, whichever comes first.
Constant speed	19 ≤ kW <37 (50 ≥ HP <50)	Less than 3.000 rpm	3.000 hours or five years, whichever comes first.
Variable speed	19 ≤ kW <37 (50 ≥ HP <50)	Any speed	3.000 hours or five years, whichever comes first.
Variable speed or constant speed	kW ≥37 (>50 HP)	Any speed	3.000 hours or five years, whichever comes first.

If any emission-related part on your engine is defective, the part will be repaired or re-placed by Motorenfabrik Hatz GmbH & Co. KG.

The warranty period shall begin:

- on the date the equipment is first delivered to the first retail purchaser, or;
- if the equipment is placed in service for demonstration purposes prior to sale at retail, on the date the engine is first placed in service.

The emission control systems of your new Motorenfabrik Hatz engine was designed, built and tested using genuine Motorenfabrik Hatz parts, and the engine is certified as being in conformity with CARB and US EPA emission control regulations. Accordingly, it is recommended that any replacement parts used for maintenance, repair or replacement of emission control systems be Motorenfabrik Hatz parts. Any replacement part that is equivalent in all material respects may be used in the performance of any maintenance or repairs, although Motorenfabrik Hatz recommends that the owner obtain assurance that such parts are warranted by their manufacturer to be equivalent to genuine Motorenfabrik Hatz GmbH & Co. KG parts. Such use shall not reduce the remaining warranty obligations of the engine manufacturer, provided they are warranted to be equivalent to genuine Motorenfabrik Hatz parts.

Any warranted part that is not scheduled for replacement, as required maintenance shall be warranted for the warranty period defined above. If any such part fails during the period of warranty coverage, it will be repaired or replaced under warranty. Any such part repaired or replaced under the warranty shall be warranted for the remaining warranty period.

Any warranted part that is scheduled only for regular inspection in the written instructions shall be warranted for the warranty period defined above. A statement in the written instructions to the effect of "repair or replace as necessary" shall not reduce the period of warranty coverage. Any such part repaired or replaced under warranty shall be warranted for the remaining warranty period.

Any warranted part that is scheduled for replacement, as required maintenance shall be warranted for the period of time prior to the first scheduled replacement point for that part. If the part fails prior to the first scheduled replacement, the part shall be repaired or replaced by the engine manufacturer under warranty. Any such part repaired or replaced under warranty shall be warranted for the remainder of the period prior to the first scheduled replacement point for the part.

Repair or replacement of any warranted part under warranty shall be performed at no charge to the owner at a warranty station.

Motorenfabrik Hatz provides warranty services or repairs at all manufacturer distribution centers (warranty stations) that are franchised to service the subject engines. Please see the Customer Assistance section of this statement for help in locating such service centers.

The owner will not be charged for diagnostic labor that leads to the determination that a warranted part is in fact defective, provided that such diagnostic work is performed at a warranty station.

Motorenfabrik Hatz is liable for damages to other engine components proximately caused by a failure under warranty of any warranted part.

OWNER'S WARRANTY RESPONSIBILITIES.

As the engine owner, you are responsible for the performance of the required maintenance listed in your owner's manual. Motorenfabrik Hatz recommends that you retain all receipts covering maintenance on your engine, but Motorenfabrik Hatz cannot deny warranty solely for the lack of receipts or for your failure to ensure the performance of all scheduled maintenance.

As the engine owner, you should be aware, however, that Motorenfabrik Hatz may deny you warranty coverage if your engine or a part has failed due to abuse, neglect, improper maintenance or unapproved modifications.

Your engine is designed to operate ultra-low sulfur fuel only. Use of any other fuel may result in your engine no longer operating in compliance with California's emissions requirements.

You are responsible for presenting your engine to a Motorenfabrik Hatz authorized service center as soon as a problem exists. The warranty repairs should be completed in a reasonable amount of time, not to exceed 30 days.

Add-on or modified parts, as defined in CCFR Section 1900(b)(1) and (b)(10), Title 13, that are not exempted by the Air Resources Board may not be used. The use of any non-exempted add-on or modified parts shall be grounds for disallowing a warranty claim made in accordance with this article. The engine manufacturer shall not be liable under this article to warrant failures of warranted parts caused by the use of a non-exempted add-on or modified part.

Customer Assistance

If you have any questions regarding your warranty rights and responsibilities, you should contact HATZ DIESEL OF AMERICA, Inc. at (262)-544-0254.

What is Not Covered by the Emission Warranty

Please note that Emission Warranty does not cover:

- Systems and parts that were not first installed on the new equipment or engine as original equipment by Motorenfabrik Hatz.
- Part malfunctions caused by abuse, misuse, improper adjustment, modification, alteration, tampering, disconnection, improper or inadequate maintenance, or use of non-recommended fuels and lubricating oils.
- Damage caused by accident, acts of nature, or other events beyond Motorenfabrik Hatz's control.
- Replacement of expendable items made in connection with scheduled maintenance.
- Parts requiring replacement, inspection or adjustment during scheduled maintenance intervals where the part is not defective.
- Parts that are not Motorenfabrik Hatz Service Parts.
- Loss of time, inconvenience, loss of use of equipment/engine or commercial loss.

- Equipment with an altered or disconnected hourmeter where the hours cannot be determined. Equipment normally operated outside the United States.
- Non-defective parts replaced by other than Motorenfabrik Hatz dealers.

What is Covered by the Emission Warranty

The following is a list of systems and parts that are considered a part of the Emission Control System and are covered by the Emission Warranty for engines that were built to conform to EPA and CARB regulations:

IMPORTANT!

This may not include expendable maintenance items. Emission related parts requiring scheduled maintenance are warranted until their first scheduled replacement point only.

The following parts as manufactured according to HATZ specifications are mandatory for engine operation which meets exhaust emission regulations:

- High Pressure pump
- Injection nozzle(s)
- Intake and exhaust manifold
- EGR valve body
- EGR rate feedback and control system
- Crankcase breather valve assembly
- Oil filler cap
- Vacuum switch
- Diesel Oxidation Catalyst
- Electronic control unit
- Oil temperature sensor
- Governor position sensor
- Engine speed sensor
- Solenoids
- Wiring harnesses
- Fuel hoses
- Intake and exhaust gaskets
- Emission Control Information Labels

Only parts manufactured by Hatz and which have passed the Hatz Quality Assurance Program have been assured of meeting EPA and CARB exhaust emission regulations.

HATZ DIESEL SUPPLEMENTAL WARRANTY FOR MODEL YEAR 2018 EPA AND / OR CARB CERTIFIED ENGINES.**PARTS WITH SUPPLEMENTAL LIMITED WARRANTY.**

The following limited warranty is supplemental to the standard HATZ DIESEL LIMITED ENGINE WARRANTY and covers Model Year 2018 EPA and / or CARB certified engines and applies to the exhaust emission-related components are also listed in this manual.

SUPPLEMENTAL LIMITED WARRANTY.

Hatz Diesel of America, Inc. hereinafter referred to as “HATZ” warrants each of the above-listed parts when installed in a new engine sold by Hatz to be free from defects in material and workmanship under normal use and service, only under the named warranty coverage conditions, after the date of delivery to the original retail purchaser and Hatz will at their option, repair or replace at Hatz’s sales headquarters, or at a point designated by Hatz, any part or parts which shall appear to the satisfaction of Hatz upon inspection at such point, to have been defective in material or workmanship.

- Any warranted part which is scheduled for replacement as required maintenance is warranted for the period of time up to the first scheduled replacement point for that part.
- Any replacement part which is equivalent in performance and durability may be used in non-warranty maintenance or repairs and will not reduce the overall engine warranty obligations of Hatz. However, Hatz is not responsible for failure of such replacement parts or failure of any other parts directly caused by failure of such replacement parts.
- This warranty does not obligate Hatz to bear any transportation charges in connection with the repair or replacement of defective parts. This warranty is transferrable to subsequent owners, only under the named warranty coverage conditions.
- In order to obtain service under this warranty, the retail purchaser should contact Hatz Diesel of America, Inc. at (262)-544-0254 for information and the nearest service center. The retail purchaser will not be charged for diagnostic labor which leads to the determination that a warranted part is defective, nor for the repair or replacement of warranted parts if the work is performed at an authorized Hatz service center. If other engine components are damaged due to a failure of the above-listed warranted parts still under warranty, these other engine components will also be repaired or replaced at no charge.
- This warranty shall not apply to any engine which shall have been installed or operated in a manner not recommended by Hatz, nor to any engine which shall have been repaired, altered, neglected, or used in any way which, in the opinion of Hatz, adversely affects its performance, nor to any engine in which parts not authorized by Hatz have been used, which parts or the use of which have damaged or caused defects in or otherwise adversely affected the engine or its performance, nor to normal maintenance service or replacement of normal service items.

Hatz reserves the right to modify, alter, and improve any engine or parts in accordance with the applicable regulations without incurring any obligation to replace any engine or parts previously sold with such modified, altered, or improved engine or parts.

EMISSION-RELATED INSTALLATION INSTRUCTIONS.

“Failing to follow the Emission related installation instructions provided by Motorfabrik Hatz when installing a certified engine in a piece of nonroad equipment violates federal law (40CFR1068.105(b)), subject to fines or other penalties as described in the Clean Air Act.”

The emission related installation instructions can be downloaded at <http://www.hatz-diesel.com/doku/assembly-instructions.html>

“If you install the engine in a way that makes the engine's emission control information labels hard to read during normal engine maintenance, you must place duplicate labels on the equipment.”

Assembly and handling of emission related components (e.g. catalyst mounting on the non-road equipment) are explained in the manual.

EQUIPMENT-LABELLING REQUIREMENTS: FUEL LABEL (see chapter 3.3 Labels, page 19)

The “ultra-low sulfur fuel only” label has to be permanently attached to the equipment.

In case of an engine mounted fuel tank, every engine is equipped with an additional fuel label nearby the fuel inlet.

Otherwise, there are two loose fuel labels available with the engine

If the original fuel label is not readily visible after the engine is installed in the equipment then the second loose fuel label must be attached on the equipment in such a manner that it is readily visible to an average person.

**CALIFORNIA
Proposition 65 Warning**

Diesel engine exhaust and some of its constituents are known to the State of California to cause cancer, birth defects, and other reproductive harm.

Motorenfabrik Hatz GmbH & Co. KG

Ernst-Hatz-Str. 16

94099 Ruhstorf a. d. Rott

Deutschland

Tel. +49 8531 319-0

Fax. +49 8531 319-418

marketing@hatz-diesel.de

www.hatz-diesel.com



CREATING POWER SOLUTIONS.

0000 436 006 04 - 01.2018 - 0.1

Printed in Germany

USA - EPA IV - CARB